

## ONGAS 300/W WALL TYPE CONDENSING BOILER

## ONGAS 300 FLOOR TYPE CONDENSING BOILER

### USER'S MANUAL



- \* ONGAS 303
- \* ONGAS 304
- \* ONGAS 305
- \* ONGAS 306
- \* ONGAS 307



- \* ONGAS 303 W
- \* ONGAS 304 W
- \* ONGAS 304/W PLUS
- \* ONGAS 305 W
- \* ONGAS 306 W
- \* ONGAS 307 W



# TABLE OF CONTENTS

1. General Information .....	5
1.1. Introduction.....	5
1.2. Certificates .....	6
1.3.1. Explanations of the Symbols .....	6
1.3.2. General Warnings and Recommendations.....	8
1.3.2.1. Points to be Considered During Handling and Transport .....	8
1.3.3. Power Saving.....	8
1.3.4. Cascade Configuration.....	9
1.3.5. Safety Instructions .....	9
1.4. Responsibilities.....	9
1.4.1 Things To Do Before Calling an Authorized Service.....	10
1.5. Explanation of the Symbols on the Packaging .....	12
1.5.1. Parts Delivered With the Product .....	13
1.6. Data and Packaging Labels.....	13
1.6.1 Gas Type Labels .....	14
2. General Specifications of the Condensing Boiler.....	14
2.1. Components of the Wall Type Condensing Boiler .....	15
2.2. Components of the Floor Type Condensing Boiler .....	15
2.3. Technical Specifications of the Wall Type Condensing Boiler.....	16
2.4. Technical Specifications of the Floor Type Condensing Boiler .....	17
3. Installation and Commissioning .....	18
3.1. Minimum Distances Recommended .....	18
3.2. Dimensions of the Wall Type Condensing Boiler .....	19
3.3. Dimensions of the Floor Type Condensing Boiler .....	19
3.4. Instructions for Installation.....	19
3.5. Gas Connections .....	20
3.6. Power Connections .....	21
3.7. Electrical Wiring Diagram.....	22
3.8. Commissioning.....	24
4.Operation of the Control Panel .....	25

4.1. Control Panel Screen .....	25
4.2. Application Modes.....	25
4.3. Programming .....	29
4.4. User Levels .....	31
4.5. Operation of Control Panel Accessories.....	34
5. Installation and Inspection of the Piping .....	35
5.1. Heating (Radiator) Water.....	35
5.1.1. Water Conditioning.....	36
5.1.2. Water Pressure .....	36
5.2. Discharging of the Condensate.....	37
5.3. Instructions for the Adjustment of Gas Ratio .....	38
5.3.1. Instructions for the Adjustment of Gas Ratio .....	38
5.4. Flue Connections .....	42
5.4.1. Examples of Installation .....	42
5.4.2. Flue Installation for ONGAS 300 Series .....	43
5.5. Hydraulic Piping Connection Diagram Examples for ONGAS 300 Series.....	44
6. Error Codes List.....	46
7. Cleaning and Maintenance .....	53
7.1. Inspection of the Burning System.....	54
7.2. Cleaning of the Modulated Fan, Venturi, Burner .....	54
7.3. Inspection of the Electrode .....	54
8. Warranty Conditions and Commissioning .....	55
8.1. Condensing Boiler Commissioning Form .....	57
8.2. Operating Instructions.....	58
8.3. Inspection of the Condensing Boiler System.....	60
8.4. List of Authorized Services .....	61

## **1.GENERAL INFORMATION**

### **1.1.Giriş**

First of all, we would like to thank you for choosing the RIMA brand.

In this manual, you will find installation and operation information for the RIMA branded wall and floor type natural gas condensing heating boilers with aluminum cast fins manufactured by ÖNMETAL.

Please read this booklet carefully in order to operate your device with high efficiency and economically, comfortably and for a long period.

DO NOT tamper with any component or setting of your device for any reason other than as described in this manual, such as operating, adjusting, or maintaining the device.

Have your device installed by Authorized Dealers.

Our Authorized Dealers and After-sales Service Centers shall provide you with the necessary information about the operation and maintenance of your device after placing the device, making the required connections and commissioning it.

In case you cannot contact with our Authorized Services and for any problems you have, our Central Technical Service shall help you.

We wish you to use your boiler in good times.

### **1.2.Certificates**

Önmetal Döküm Sanayi ve Tic. Ltd. Şti. is certified with the Certificate of Competency with After-sales Services as per TS 12676 Authorized Services - The Rules for the Boilers and Heat Exchangers as the scope of the service dated and numbered 14.09.2011/0 and issued by the T.R. MINISTRY OF CUSTOMS AND TRADE's Directorate General of Consumer Protection And Market Surveillance, and with the Service Place Competency Certificate issued by TSE.

The structure and operation of the boilers comply with the Regulations of European Union and the conditions stipulated in the regulations of all countries in which the European Union Standard is applicable.

ONGAS 300/W and ONGAS 300 Series Wall and Floor Type Condensing Boilers are the registered brands of Önmetal Döküm Sanayi ve Tic. Ltd. Şti. and they are manufactured in the own facilities of the company in Edirne, Turkey.

- **2016/426/EU** – Gas Appliances Regulation
- **2014/35/EU** – Low Voltage Directive
- **2014/30/EU** – Electromagnetic Compatibility Directive
- **92/42/EEC** – Efficiency Directive
- **813/2013/EU** – Ecodesign Regulation
- **2009/125/EC** – Ecodesign Requirements Directive (implementing directive)



RIMA ONGAS 300/W Wall Type ONGAS 300 and Floor Type Condensing Boilers comply with the **EC Directives**.

### 1.3.1.Explanations of the Symbols



Warning Signs



Safety Warnings are indicated with a warning triangle.

Important information for the safety of persons are indicated with the symbol on the left

### 1.3.2.General Warnings and Recommendations



• ONGAS 300/W and ONGAS 300 Series Wall and Floor Type Condensing Boilers with Aluminum Cast Fins are designed to be used in heating installations with domestic hot water and/or in domestic hot water installations and manufactured with the technology and materials suitable for this design. They shall not be used for this intended use.

- While placing the boiler in the boiler room, the point where the boiler shall be installed and operated shall have a concrete base that is stable and strong enough to bear the weight of the boiler.
- Example installation diagrams are provided at the end of the manual. Installations for the boilers shall be made according to these diagrams. Only the general installation principle of the system and the sensors and relay points used for automation are provided in these diagrams. Installation elements such as sediment traps, check valves, expansion tanks are not indicated. These equipment shall be selected and installed separately.
- Sufficient space shall be left around the boiler while placing it in the boiler room for maintenance and service operations.
- In the installation, a sediment trap shall be placed in the secondary circuit after the balance vessel and an air separator shall be placed in the primary circuit after the balance tank.
- Commissioning and adjustment of the boiler shall be performed Authorized Service Centers of RIMA. See p.58
- In the summer months when the boiler is not operated, the circulation pumps shall be operated for five minutes 1-2 times a month to prevent jamming and to extend their service life. (Lime water causes malfunctions if the boiler is not used for a long period).
- Capacity selection of the boiler shall be performed according to the installation projects prepared in accordance with the standards. Otherwise it may not be possible to obtain the desired efficiency from the boiler.
- ONGAS 300/W and ONGAS 300 Series Wall and Floor Type Condensing Boilers are intended for heating systems only as standard. Another boiler or a heat exchanger is also required to heat the domestic water. To provide efficient hot water, the capacities of the boiler and the external boiler or heat exchanger shall be compatible.
- If the boiler has stopped automatically due to over-temperature, do not add cold water to the boiler to restart the boiler. Wait until the boiler has cooled down and then try restarting, if it does not, inform the authorized service.
- Electrical supply of the boiler is provided from the mains. For this reason, power and lighting installation of the boiler room, electrical connections of the boiler, control panels and boiler room grounding line shall be made by experts of their field in accordance with the relevant standards

- It is suitable for Vented and Hermetic (B and C type) applications, designed for central heating and optionally for the circulation of domestic hot water.
- All electrical and electronic controls are supported on the control panel located at the top of the boiler.
- **The cleaning of the installation is of utmost importance for the transformation projects from boilers with solid fuel or liquid fuel to boilers with gas fuel. The installation shall be washed, any leaks shall be detected and repaired and a plate type heat exchanger shall be used.**
- Boilers shall be installed in a place with no risk of frost. When the boiler is not operated, the water remaining in the radiators shall be drained to prevent freezing.
- Boilers shall not be installed in a location that contains moisture, vapor or dust. Otherwise the boiler shall not operate correctly and efficiently.
- The floor of the installation location of the boiler shall be stable, firm and wide, and it shall be positioned high above the ground in order not to be affected by floods.
- The supply of fresh air shall be free of halogen hydrocarbons (sprays, paints and some chemicals), otherwise these shall cause corrosion and erosion of the boiler and flue.
- Flammable materials shall not be placed on or near the boiler.
- Fresh air intake shall comply with the instructions of the local gas supplier and the instructions for gas connection, otherwise there is a risk of poisoning.
- Condensate and flue connections shall be made in accordance with the rules and standards.
- Before starting to work on the boiler, always disconnect the main power line and turn off the main gas valve.
- If you smell gas, turn off the main gas valve and call the emergency number for gas leaks in your neighbourhood. If you smell flue gas, turn off the boiler and call the authorized service immediately

Combustibility (flammability) levels of construction materials and products	
A- Non-combustible	Granite, sandstone, concrete, brick, ceramic, fireproof plasters
B- Very Difficult to Burn	acumin, isumin, heraclith, lignose, fiberglass components
C1- Difficult to Burn	Products made of beech or oak, hobrex plates, werzalit, umuakart
C2- Medium Combustibility	Wet wood, black pine, cork and tree crumbs, rubber sole
C3- Easy to Burn	Asphalt Components, Fiber components, cellulose materials, polyurethane, polystyrene, PVC, polyethylene

Keep the boilers at least 200 mm away from flammable materials with B, C1, C2 burning classes as specified in the table during their installation and operation.

- For materials that burn rapidly and by themselves after any spark, that are easily ignitable with a burning class of C3, increase the safety distance to at least 400 mm.

The boiler is set for natural gas H/E (G20, 20 mbar) in the factory.

- The boiler shall only be installed in a room that meets proper ventilation requirements and that is separated from living areas. Otherwise there is a risk of suffocation or poisoning.

- To prevent incorrect circulation, control valves shall be used in conjunction with the circulation pump system. A strainer (filter) shall be used in the return water lines of the new/old buildings and new/old installation systems.
- A relief valve (max. 6 bar) and a manometer shall be used in the installation system. No other valves shall be present between the boiler and the relief valve, otherwise pipes or other parts may explode in the over-pressurized boiler (risk of evaporation).
- Supply of cold water to the boiler shall be performed when the boiler is cold.
- It is possible that oxygen may pass through the floor heating pipes into the water. Oxygen in the water causes corrosion of the boiler. Therefore, if the boiler is to be used in a floor heating system, a heat exchanger shall be added to the circuit and mixing of the boiler water and installation water shall be prevented.
- The external air sensor is delivered with the device as standard to ensure more economical operation of the boilers. This sensor allows fuel savings about 35%. Moreover, optional controller units may be installed to allow scheduling of the boiler. Similar applications are also implemented in cascade systems.

The boiler shall only be installed in a room that meets proper ventilation requirements and that is separated from living areas. Otherwise there is a risk of suffocation or poisoning. Read the technical instructions before installation and operation.

### **1.3.2.1. Points to be Considered During Handling and Transport**

- Products are shipped on pallets as protected by styrofoam and film.
- The products are fastened to the pallets with retaining screws.
- In addition, the products are protected with a wooden case against external impacts.
- Appropriate markings are provided on the case. During storage, it may be stored at proper ambient humidity and temperature without opening the package.

### **1.3.3. Power Saving**

The proper use of energy resources in our world is a real problem of modern societies. While we are generating energy for our future, we use natural resources that shall be exhausted in the near future unless we encourage more rational and efficient use of these resources.

 Condensation technology is a big step towards the rational use of energy as it provides energy savings of up to 35% and lower emission values (80% for CO and 90% for NOx) compared to conventional heating systems.

Moreover, the annual CO<sub>2</sub> emission values of high efficiency condensing boilers are 20% less in average than the boilers with standard efficiency.

In the countries that have advanced in technology, all of the new boiler installations are selected as condensing boilers and the governments have started to encourage persons to choose this technology.

The device offers intuitive and advanced diagnostic systems that allows detection of faults by the user.



### 1.3.4. Cascade Configuration

The use of wall and floor type condensing boilers in central systems is increasing every day. Condensing boilers designed for this purpose provide high capacities with low space requirement. An advantageous and economical heating is ensured by reaching a capacity of 187 kW in one boiler and a max. capacity of 2,992 kW with a cascade system. It allows easy installation and easy operation with its compact design which reduces the space requirement. Provides ease of installation in confined spaces thanks to its easily accessible internal structure. ONGAS 300/W and ONGAS 300 series provide excellent compatibility when they are installed to replace old systems that have expired their service life. Condensation technology with advanced control systems reduces your fuel costs by 30%-40% by providing fuel savings from the first day of operation. Allows cascade operation even in areas with a very limited installation space thanks to its compact design and light weight.

### 1.3.5. Safety Instructions



The boiler is connected to 230V mains.

An incorrect installation or any attempts to repair using incorrect electrical components may pose a lethal risk.



Keep unauthorized personnel away from the boiler. Do not leave any objects on or near the boiler.



Do not touch the hot water connections or the flue outlet during the operation of the boiler - risk of burning.



Installation, repair, commissioning and maintenance operations shall only be carried out by suitably qualified personnel. It complies with all relevant international/local standards and certificates.



Before starting to work on the boiler, always disconnect the main power line and turn off the main gas valve.

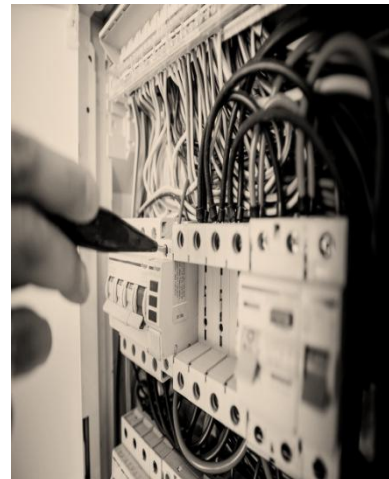

If you smell gas, turn off the main gas valve and call the emergency number for gas leaks in your neighborhood. If you smell flue gas, turn off the boiler and contact the authorized service or the installer.

## 1.4. Responsibilities

**Manufacturer's Responsibilities:** They shall manufacture and ship products in accordance with the relevant directives

**Responsibilities of the Contractor:** Contracting company is responsible for the installation. The company shall read this manual and follow the instructions provided in the manual before calling the authorized service.

### 1.4.1.Points to Consider Before Contacting the Authorized Service

First of all, we would like to thank you for choosing and using the “Rima Condensing Boiler”. Below is a list of things to do before calling the Rima Authorized Service.

- Protect your device against factors that may damage the packaging and the device (moisture, water, impact, construction materials, etc. ) during the transport and subsequent assembly of the device. The boilers shall be installed on a stable, firm ground. In case of a surface which is not suitable for supporting of the boilers and the connection equipment, a suspension system with a metal profile shall be used.
- The installation water shall be conditioned by considering whether the system is a new heating system to be installed or an heating system to be transformed. If the installation to be used for the system is old or if it shall be transformed, the water in the installation shall be completely drained and water shall be conditioned (cleaning shall be performed and a preservative shall be used). We recommend the use of plate heat exchangers in such systems particularly. The presence of blockages in the heating installation such as dirt, sediment, burrs, iron dust, lime, etc., adversely affect the operation of the boiler. This may cause inefficient operation, overheating, noisy operation, and damage to the heat exchanger of the boiler over time. Installation water shall be conditioned and preserved in new installations.
  - $7 < \text{pH value used in the installation} < 8.5$
  - For the hardness of the water, the hardness value appropriate to the capacity shall be determined in accordance with the table given below.

• Total capacity (kW)	• Total hardness (French hardness - ° F)		
	• Total volume of the system (less than 20 l/kW)	• Total volume of the system (between 20-50 l/kW)	• Total volume of the system (higher than 50 l/kW)
• $\leq 50$	• $\leq 30$	• $\leq 20$	• $< 0.2$
• $> 50 \leq 200$	• $\leq 20$	• $\leq 15$	• $< 0.2$
• $> 200 \leq 600$	• $\leq 15$	• $< 0.2$	• $< 0.2$
• $> 600$	• $< 0.2$	• $< 0.2$	• $< 0.2$

- Water containing sediment or of unknown content such as well water and transport water shall not be used. Use of any chemicals by adding them to the installation without the approval of the manufacturer shall render the products void of warranty. As Rima Heating Systems, we recommend use of water treatment products with Sentinel X100, X300 or X400 brands. Use neutral, non-acidic and non-alkaline cleaners. Any damage to the product or installation that may occur without taking the approval of the manufacturer in applications performed using the products of different companies is out of warranty cover. It is the user’s responsibility to ensure that the water to be circulated in the installation is clean.
- Sub-boiler pumps, hydraulic sets, balance vessels, sediment traps, air separators to be used in the installation shall be selected as suitable to the boiler and heating installation.
- A distance of 10 cm between each boiler shall be provided for ease of installation and service for wall type condensing boilers.

## Selection of the Balance Tank

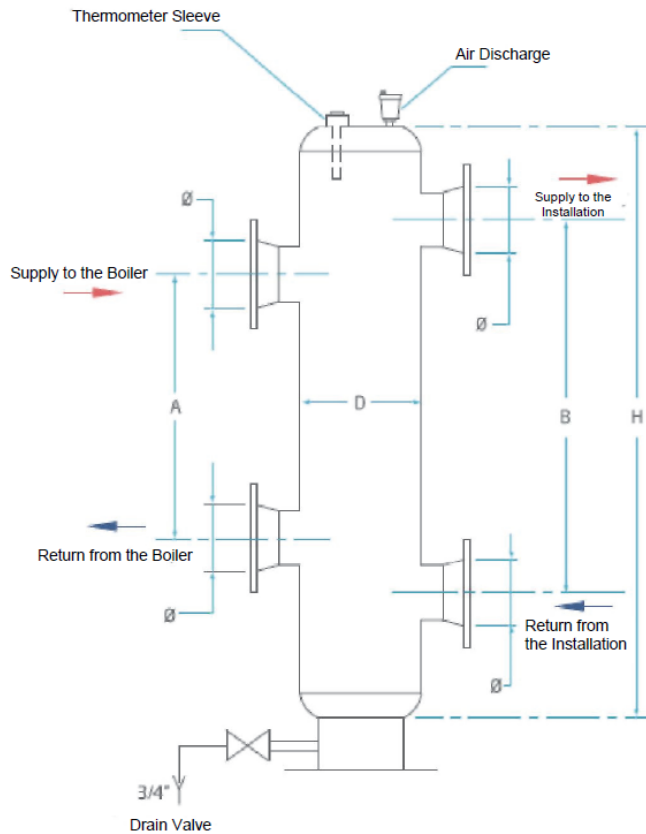

System Capacity (kW)	A (cm)	B (cm)	H (cm)	D Diameter of the Balance Vessel (mm)	Ø Inlet - Outlet Diameter (mm)
65	33	38	48	100	50
90	36	44	55	125	50
115	42	47	59	125	65
130	47	54	68	150	65
170	54	62	77	150	30
230	59	67	84	200	30
345	72	82	103	200	100
460	33	95	119	250	100
575	93	106	133	250	125
690	102	116	145	303	125
805	110	126	157	300	150
920	118	134	168	350	150
1035	131	150	188	350	150
1150	138	157	197	403	200
1265	144	164	205	403	200
1380	150	171	214	450	200
1495	155	178	222	450	200
1610	162	185	230	450	200
1725	169	192	238	450	200

- Pumps to be installed under each boiler in the heating system shall be selected as energy efficient pumps. The recommended pump models are given below; and when different brands of pumps are chosen, the flow rates and pump heads and the pump inlet diameters of the chosen pumps shall be the same with the recommended pumps.

Boiler Models	Grundfos	Wilo	Pump Diameters
<b>Ongas 303/W</b>	Upml 25/105	Yonos Para 25/7	DN 25
<b>Ongas 304/W</b>	Upml 32/105	Yonos Para 32/10	DN 32
<b>Ongas 304 /W plus</b>	Upmxi 32/125	Yonos Para 32/10	DN 32
<b>Ongas 305/W</b>	Upmxi 32/125	Yonos Para 32/10	DN 32
<b>Ongas 306/W</b>	Magna 40/120	Yonos Para 40/12	DN 40
<b>Ongas 307/W</b>	Magna 40/120	Yonos Para 40/12	DN 40

- A separate flue outlet shall be made for each boiler and each flue shall be connected to the main flue from the sides. In case of connection to existing flues, make sure that they are clean, otherwise the flues may prevent the passing of gases during operation.
- All electrical installations are the responsibility of the contractor. Connect your device to a 220 - 230 V single phase and grounded power supply. Connections to the boiler shall be performed by the authorized service. All connections to be made on the electrical panel through the boiler shall be performed by Rima authorized service centers. If it is desired that

the electrical installation is also performed by the authorized service, labor costs shall be subject to a charge to be determined by the service.

- A certificate of conformity shall be taken from the gas companies before calling the service.
- Ongas 300 W may only be operated with natural gas. Gas pressure in the gas line shall be set to 21 mbar with a regulator and a filter shall be present in the gas line.
- Any leaks in the installation shall be repaired. Faults and damages that may occur due to power-water-gas installations and/or installation equipment, leaks in the installations, installation connections, and flue connections are out of the warranty cover. Automatic supply shall not be applied.
- The systems where our gas fueled condensing boilers shall be installed are closed-circuit systems. In closed-circuit systems, a closed expansion tank shall be used. An open expansion tank shall not be used.
- The application pressure of the system is between 0.8 bar and 6 bar. Since the closed-circuit operating pressure allowed by the boiler is maximum 6 bar, a balance vessel shall be used for pressures up to 6 bar, and a plate heat exchanger shall be used instead of the balance vessel for pressures over 6 bar in cascade systems. A relief valve with adjustable pressure is not allowed. When a plate heat exchanger is used, expansion tanks with suitable capacity shall be used on both sides of the system
- The boiler drainage shall be directed so that flowing of the condensation water is allowed. The materials used for the installation the condensate drainage shall be made of plastic. Blocking the condensate drain shall cause the boiler to shut down automatically or leak from the siphon. If you suspect a frost condition, it shall be useful to pour hot water into the exposed part of the drain. Always ensure that the drain is open to ensure that the boiler functions properly.
- It is essential to use a manometer that indicates the operating pressure in the system.
- Procurement of the zone control module and its installation to the boiler control panel is the responsibility of the user.
- The heating system has a protection function for conditions with a risk of frost. To enable this function, the power to the boiler room shall be switched on
- Faults and damages that occur due to the environmental conditions and incorrect storage by the consumer are not covered by the warranty.

**IMPORTANT:** If deficiencies in the system are detected by the service personnel during the commissioning, our service shall not commission the system; and the service fee incurred when the service is called again for commissioning following the provision of the necessary conditions in the system shall be borne by the user.

Responsibilities of the User: Reading the manuals, maintaining and preserving the product in accordance with the warranty conditions, and preventing the intervention of persons other than the authorized service.

### 1.5. Explanation of the Symbols on the Packaging

Fragile



Top side



Recycle



Protect Against Water



All gas devices shall be installed by qualified technicians. Any error in the installation of these devices may result in criminal actions as required. RIMA ONGAS 300 / W and ONGAS 300 condensing boilers shall not be installed or modified in any way other than those specified in this manual. Always keep the boiler in its safety packaging during its transport before installation. Additional protection measures may when required by the installation site. Please follow the rules and instructions for the authorization of the installation.

#### Packaging Label:

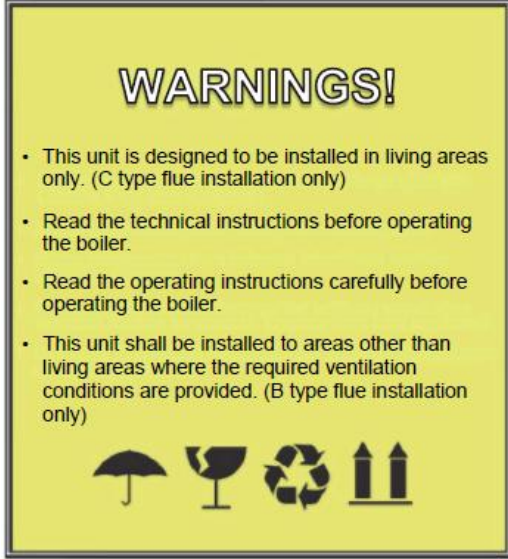

#### 1.5.1. Parts Delivered as Standard with the Product

- Siphon Assembly
- Operating Manual
- Warranty Certificate

Important: Operating instructions to ensure that the boiler may be used without any problem for many years are included in the operating manual.

#### 1.6.Data Label – Wall Type Boilers / Floor Type Boilers

**rima**  0051-19

ONGAS 300 AND ONGAS 300/W SERIES CONDENSING BOILERS  
**Model:** ONGAS 303  
**Year of Production:** 2019  
**Nominal Thermal Power (80/60°C) - Min/Max:** 14/62 kW  
**Nominal Thermal Power (50/30°C) - Min/Max:** 16/69 kW  
**Thermal Load - Min/Max:** 15/65 kW  
**Maximum Head:** 6 bar  
**Power Supply:** 230 W 50 Hz  
**Consumed Power:** 160W  
**NOx Class:** 5  
**Flue Application Types:** B23, C63

Product Code:  5 996093 673007

COUNTRIES TO DELIVER	GAS PRESSURE "P" (mbar)	GAS CATEGORY
OE	20	12ELL
AL, BG, HR, RO, AT, CH, SK, RU	30	12H
ES, GB, IE, IT, PT, SI, CZ, TR	20	12H
EE, DK, FI, LT, LV, NO, SE	20	12H
FR	20	12E
BE	20	12E (R) B
LU	20	12E
ML	25	12L
PL	20	12ELw
HU	25	12H

NOTE: This boiler is set in factory for operating with G20-20 mbar natural gas.

**Manufacturer:**  Onmetal Döküm Sanayi ve Tic. Ltd. Sti.  
 İkitelli OSB Mah. 25 Cad. No:10  
 PK: 34306 Başakşehir  
 İstanbul/TURKEY  
 Tel: +90 212 435 48 74  
 Fax: +90 212 435 48 73

Serial No.:  33 0819 00000

**rima**  0051-19

ONGAS 300 AND ONGAS 300/W SERIES CONDENSING BOILERS  
**Model:** ONGAS 303  
**Year of Production:** 2019  
**Nominal Thermal Power (80/60°C) - Min/Max:** 14/62 kW  
**Nominal Thermal Power (50/30°C) - Min/Max:** 16/69 kW  
**Thermal Load - Min/Max:** 15/65 kW  
**Maximum Head:** 6 bar  
**Power Supply:** 230 W 50 Hz  
**Consumed Power:** 160W  
**NOx Class:** 5  
**Flue Application Types:** B23, C63

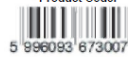
Product Code:  5 996093 673007

COUNTRIES TO DELIVER	GAS PRESSURE "P" (mbar)	GAS CATEGORY
OE	20	12ELL
AL, BG, HR, RO, AT, CH, SK, RU	30	12H
ES, GB, IE, IT, PT, SI, CZ, TR	20	12H
EE, DK, FI, LT, LV, NO, SE	20	12H
FR	20	12E
BE	20	12E (R) B
LU	20	12E
ML	25	12L
PL	20	12ELw
HU	25	12H

NOTE: This boiler is set in factory for operating with G20-20 mbar natural gas.

**Manufacturer:**  Onmetal Döküm Sanayi ve Tic. Ltd. Sti.  
 İkitelli OSB Mah. 25 Cad. No:10  
 PK: 34306 Başakşehir  
 İstanbul/TURKEY  
 Tel: +90 212 435 48 74  
 Fax: +90 212 435 48 73

Serial No.:  33 0819 00000

### 1.6.1. Gas Type Label

COUNTRIES TO DELIVER	GAS PRESSURE "P" (mbar)	GAS CATEGORY
DE	20	I 2ELL
AL, BG, HR, RO, AT, CH, SK	20	I 2H
ES, GB, IE, IT, PT, SI, CZ, TR	20	I 2H
EE, DK, FI, LT, LV, NO, SE	20	I 2H
FR	20	I 2Er
BE	20	I 2E (R) B
LU	20	I 2E
NL	25	I 2L
PL	20	I 2ELw
HU	25	I 2H



**The boiler is set for natural gas H/E (G20, 20 mbar) in the factory.**

## **2. GENERAL SPECIFICATIONS OF THE CONDENSING BOILER**

The operating principle of the condensing boiler is similar with the hermetic devices. The most important difference is the structure of the heat exchanger and the fact that it has a larger surface area to absorb more heat from the flue gases.

The design and structure of the main heat exchanger is capable of reducing the temperature of flue gases below 54°C and cooling the flue gases when the temperature of the boiler return water is sufficiently low. The water vapor in the flue gases of which the temperature is reduced below 54°C is condensed and the latent heat in the water vapor is recycled to the system. The waste heat would be discharged to the atmosphere with the flue gases if this recovery is not performed.

While the flue gas temperatures are about 200–250°C in conventional boilers, this value is about 50–60°C in condensing boilers, and this is where the potential recovery is obtained.

Common features of the burners used in condensing devices:

- Operating with high efficiency,
- Wide modulation ranges,
- Ease of setting according to the gas types used,

The fact that they are designed considering ease of service and maintenance.

While the devices may meet the requirement for small capacity with a very low power (such as 18 kW) in these systems, they may also be operated at full capacity when required. Moreover, applications with multiple boilers (cascade applications) from the minimum capacity up to 2992 kW are also allowed according to the product models for larger capacity requirements. By providing modulation between 18 kW and 2992 kW, the required heat is produced in the most efficient way according to the current heating requirement of the building, thus both fuel economy and a clean combustion that is free of the operating style called stop-start operation are provided thanks to continuous combustion.

## 2.1.Components of the ONGAS 300/W Wall Type Condensing Boiler

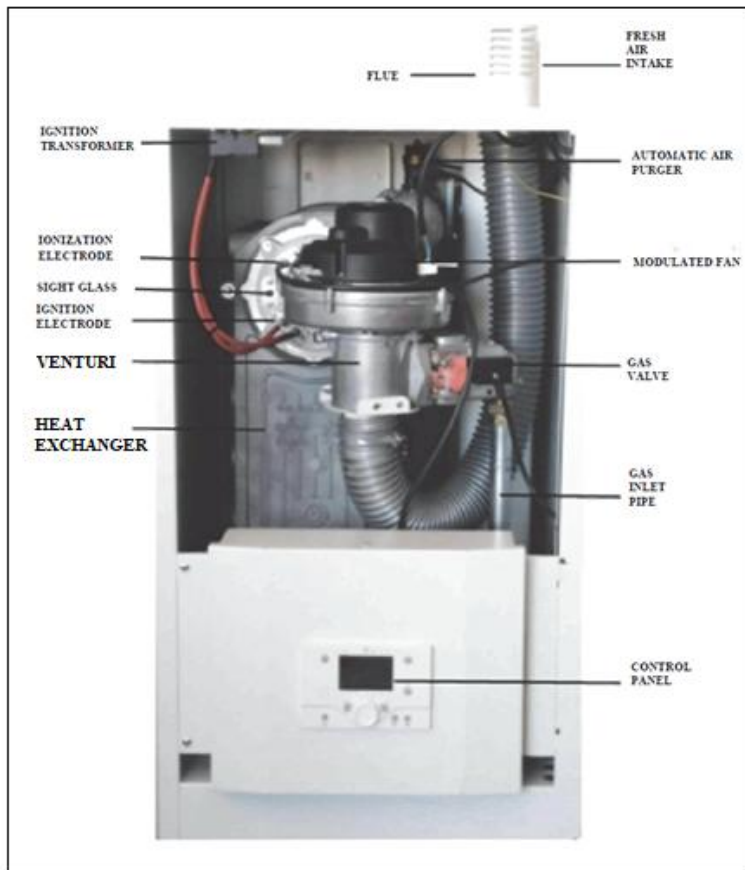

## 2.2.Components of the ONGAS 300/W Floor Type Condensing Boiler

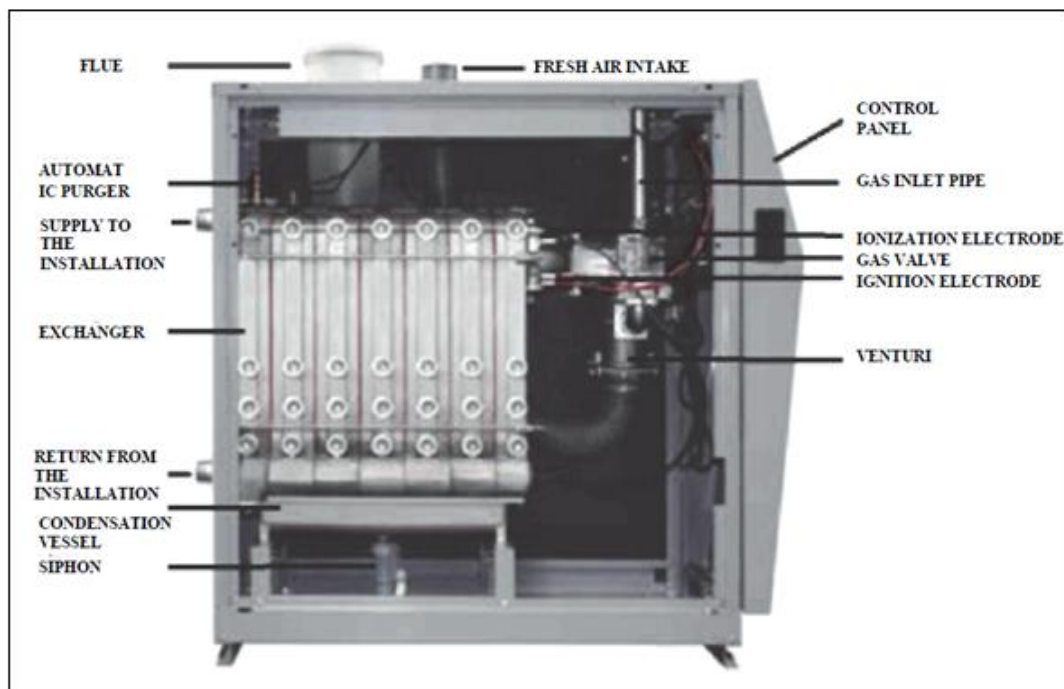

### 2.3. Technical Specifications of the Wall Type Condensing Boiler

ONGAS 300 /W Series		303W	304W	304 WP	305W	306W	307W
<b>Efficiency and Performance</b>							
Maximum thermal load at heating mode	kW	65	95	110	119	148	180
Minimum thermal load at heating mode	kW	15	20	20	19	34	38
Maximum thermal power at heating mode (80/60°C)	kW	62	90	109	115	142	171
Minimum thermal power at heating mode (80/60°C)	kW	14	19	19	18	33	37
Maximum thermal power at heating mode (50/30°C)	kW	69	100	115	124	154	187
Minimum thermal power at heating mode (50/30°C)	kW	16	22	22	21	37	41
Efficiency at full load (80/60°C)	%	96.2	94.7	97.5	96.4	96	95.1
Efficiency at minimum load (80/60°C)	%	93.7	94.8	94.8	94.8	96.2	96.4
Efficiency at full load (50/30°C)	%	106.4	105.2	104.5	104.3	103.8	103.7
Efficiency at minimum load (50/30°C)	%	107.1	108.3	108.3	108	109.4	109.5
Efficiency at partial load (30%) (30°C return temperature)	%	105.8	105.3	108.4	105.7	106.2	106.6
NOx class		5					
Maximum heating mode setting temperature	°C	80					
Maximum domestic water setting temperature	°C	65					
Maximum heat exchanger ΔT protection temperature	°C	26					
Flue waste gas pressure at full load	pascal	230	230	260	180	210	190
Applied water pressure (min – max)	bar	0.8 - 6					
Noise level (at 1 m from the boiler)	dB	35	41	44	48	52	55
<b>Structural specifications</b>							
Water volume	liters	6.5	8.5	8.5	10.5	12.5	14.5
Dry weight	kg	65	82	88	103	130	167
<b>Electrical specifications</b>							
Supply	V/Hz	230/50					
Protection level	IP	IPX4D					
Power consumption	W	190	190	190	190	310	315
<b>Water and gas connections</b>							
Water inlet-outlet diameters		1"	1 ¼"			1 ½"	
Gas inlet		¾"				1"	1 ¼"
Waste gas outlet (Ø)		80	100	100	110	125	160
<b>Values for burning</b>							
Flue application		B23, C63, C13, C33	B23, C63				
Burning efficiency at full load		98.2	98.2	98.3	98.3	98.2	98.1
Burning efficiency at minimum load		98.4	98.4	98.4	98.5	98.4	98.4
Flue gas temperature at full load (80/60°C)		59.3	60.8	62.3	59.9	59.7	61.4
Flue gas temperature at minimum load (80/60°C)		58.7	56.4	56.3	55.3	57.3	56.3
Flue gas temperature at full load (50/30°C)		41.8	39.4	42.4	40.4	42.1	42.6
Flue gas temperature at minimum load (50/30°C)		30.8	30.5	31.5	29.9	31.6	30.9
Waste gas output flow rate at full load		29.5	38.4	41.7	48.7	62.6	77
Waste gas output flow rate at minimum load		9.6	11.8	13.4	14.6	19.7	24.5
CO <sub>2</sub> at Pmax		9.2	9.6	9.3	9.3	9.4	9.7
CO <sub>2</sub> at Pmin		9	9.1	9.1	9.1	9.1	9.2
CO O <sub>2</sub> =0% at Pmax		124	142	171	116	96	140
CO O <sub>2</sub> =0% at Pmin		18	16	15	10	28	18
NOx O <sub>2</sub> =0% at Pmax		38.14	39.11	42.75	51.6	37.33	59.58
NOx O <sub>2</sub> =0% at Pmin		16.05	15.88	13.54	11.34	9.07	8.97
NOx O <sub>2</sub> =0% weighted		22.39	25.64	24.73	23.95	18.13	31.43



## 2.4. Technical Specifications of the Floor Type Condensing Boiler

ONGAS 300 Series		303	304	305	306	307
<b>Efficiency and Performance</b>						
Maximum thermal load at heating mode	kW	65	95	119	148	180
Minimum thermal load at heating mode	kW	15	20	19	34	38
Maximum thermal power at heating mode (80/60°C)	kW	62	90	115	142	171
Minimum thermal power at heating mode (80/60°C)	kW	14	19	18	33	37
Maximum thermal power at heating mode (50/30°C)	kW	69	100	124	154	187
Minimum thermal power at heating mode (50/30°C)	kW	16	22	21	37	41
Efficiency at full load (80/60°C)	%	96.2	94.7	96.4	96	95.1
Efficiency at minimum load (80/60°C)	%	93.7	94.8	94.8	96.2	96.4
Efficiency at full load (50/30°C)	%	106.4	105.2	104.3	103.8	103.7
Efficiency at minimum load (50/30°C)	%	107.1	108.3	108	109.4	109.5
Efficiency at partial load (30%) (30°C return temperature)	%	105.8	105.3	105.7	106.2	106.6
NOx class		5				
Maximum heating mode setting temperature	°C	80				
Maximum domestic water setting temperature	°C	65				
Flue waste gas pressure at full load	pascal	230	230	180	210	190
Applied water pressure (min – max)	bar	0.8 - 6				
Noise level (at 1 m from the boiler)	dB	35	41	48	52	55
<b>Structural specifications</b>						
Water volume	liters	6.5	8.5	10.5	12.5	14.5
Gross weight	kg	112	142	180	218	247
<b>Electrical specifications</b>						
Supply	V/Hz	230/50				
Protection level	IP	IPX4D				
Power consumption	W	190	190	190	310	315
<b>Water and gas connections</b>						
Water inlet-outlet diameters		1"	1 ¼"		1 ½"	
Gas inlet		¾"			1"	1 ¼"
Waste gas outlet (Ø)		80	100	110	125	160
<b>Values for burning</b>						
Flue application		B23, C63 C13, C33	B23, C63			
Burning efficiency at full load		98.2	98.2	98.3	98.2	98.1
Burning efficiency at minimum load		98.4	98.4	98.5	98.4	98.4
Flue gas temperature at full load (80/60°C)		59.3	60.8	59.9	59.7	61.4
Flue gas temperature at minimum load (80/60°C)		58.7	56.4	55.3	57.3	56.3
Flue gas temperature at full load (50/30°C)		41.8	39.4	40.4	42.1	42.6
Flue gas temperature at minimum load (50/30°C)		30.8	30.5	29.9	31.6	30.9
Waste gas output flow rate at full load		29.5	38.4	48.7	62.6	77
Waste gas output flow rate at minimum load		9.6	11.8	14.6	19.7	24.5
CO <sub>2</sub> at Pmax		9.2	9.6	9.3	9.4	9.7
CO <sub>2</sub> at Pmin		9	9.1	9.1	9.1	9.2
CO O <sub>2</sub> =0% at Pmax		124	142	116	96	140
CO O <sub>2</sub> =0% at Pmin		18	16	10	28	18
NOx O <sub>2</sub> =0% at Pmax		38.14	39.11	51.6	37.33	59.58
NOx O <sub>2</sub> =0% at Pmin		16.05	15.88	11.34	9.07	8.97

### **3. INSTALLATION AND COMMISSIONING**

#### **3.1.Packaging and Handling**

Products are shipped on pallets as protected by styrofoam and film. The products are fastened to the pallets with retaining screws. In addition, the products are protected with a wooden case against external impacts. Appropriate markings are provided on the case. During storage, it may be stored at proper ambient humidity and temperature without opening the package.

The minimum distances that shall be left from the floor, right and left sides of the device for the installation of the Condensing Boiler have been calculated by considering the minimum distances required to allow the personnel to open the covers of the boiler easily and ergonomically.

Recommended minimum distances for wall type boilers:

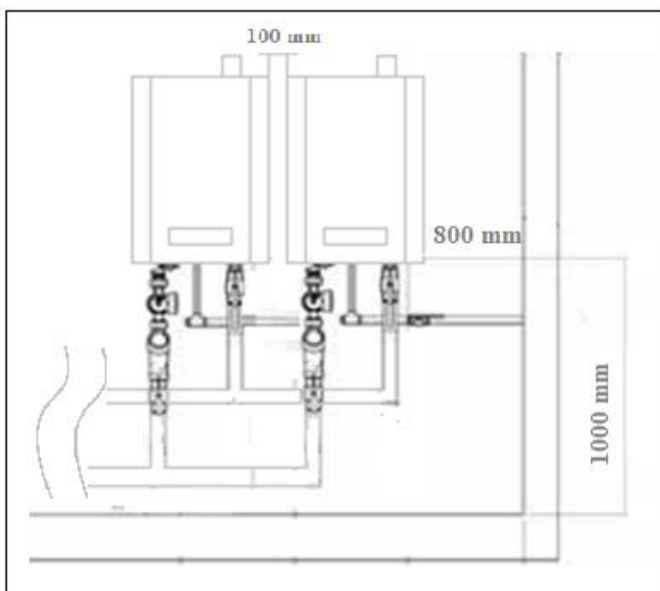

Recommended minimum distances for floor type boilers:

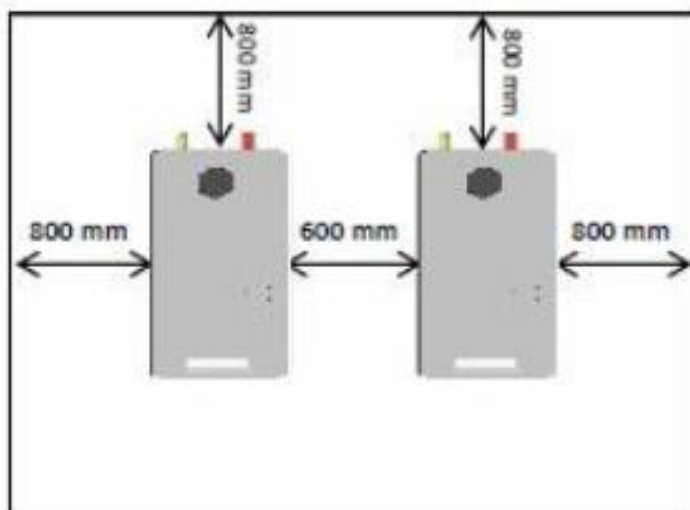

### 3.2. Dimensions of the Wall Type Condensing Boiler



(mm)	303	304	305	306	307
L	460	560	710	860	1010
W	500				
H	750				

### 3.3. Dimensions of the Floor Type Condensing Boiler



(mm)	303	304	305	306	307
L	850	1000	1250	1420	1560
W	580			700	
H	1400			1470	

### 3.4. Instructions for Installation

RIMA ONGAS 300 Series Condensing Boiler shall be placed as follows

- Place the boiler to the boiler room taking the minimum recommended distances into account.
- Remove the gelatin, tapes, pallets and any other packaging.
- All gas appliances shall be installed by authorized persons as required by law. Any error in the installation of these devices may cause loss of life and property.
- Boilers shall be installed in a place with no risk of frost. When the boiler is not operated, the water remaining in the radiators shall be drained to prevent freezing.
- Boilers shall not be installed in a location that contains moisture, vapor or dust. Otherwise the boiler shall not operate correctly and efficiently.
- The floor of the installation location of the boiler shall be stable, firm and wide, and it shall be positioned high above the ground in order not to be affected by floods.

- The supply of fresh air shall be free of halogen hydrocarbons (sprays, paints and some chemicals), otherwise these shall cause corrosion and erosion of the boiler and flue.
- Fresh air intake shall comply with the instructions of the local gas supplier and the instructions for gas connection, otherwise there is a risk of poisoning.
- Condensate and flue connections shall be made in accordance with the rules and standards.

### 3.5. Gas Connections

- Gas connections shall be performed by authorized personnel or by installation companies with certification for gas installations.
- Sediments and collected particles in old installations, radiators or gas pipes shall be removed before installation.
- The gas connections shall be inspected for leakage before commissioning.
- The risk of poisoning or explosion due to the operation and installation of unsuitable gas installations may result from non-compliance to rules.
- A flameproof gas valve shall be used, otherwise there is a risk of explosion in case of fire.
- Gas connections shall be made in accordance with the standards and directives.



Perform the gas leak test while the gas control valve is **TURNUED OFF**. Gas valves may be subjected to a max. pressure of 150 mbar. When this pressure is exceeded, gas valves and burners may be damaged, and this result in explosions and poisoning. During the pressure test of the gas compartment, the valve at the inlet of the device shall be turned off. Please note the type of gas used in the boiler and the instructions for transformation.

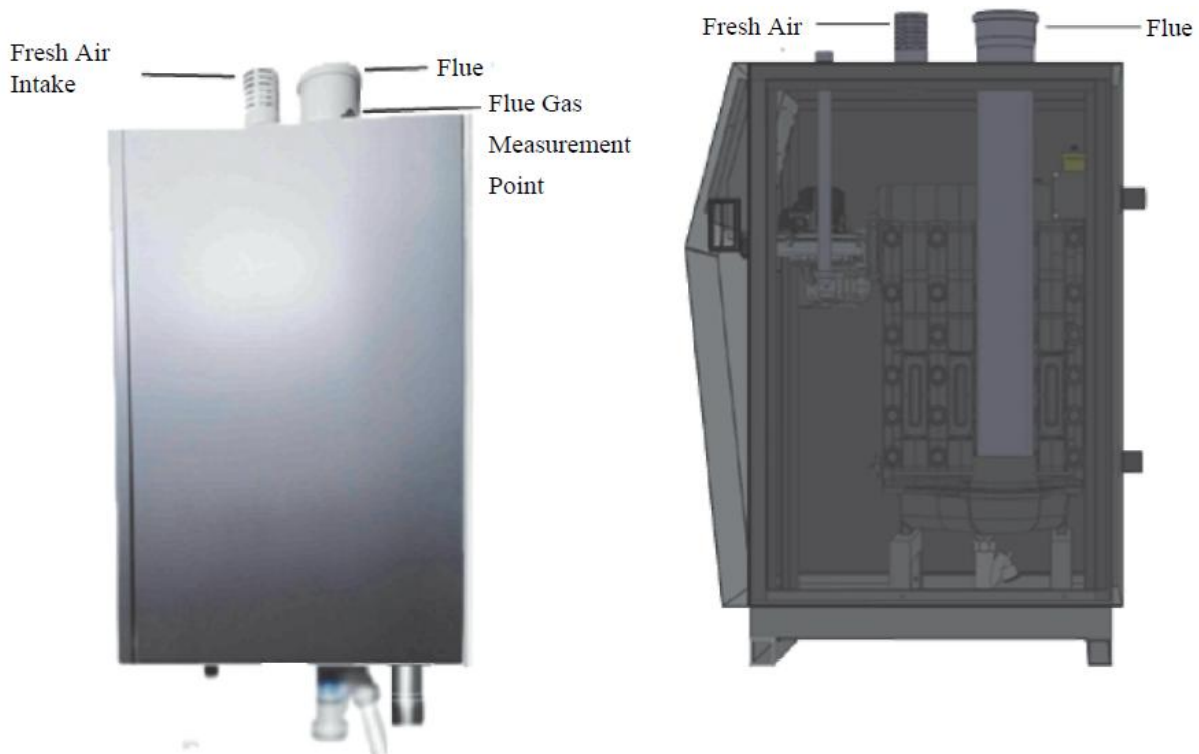

Only the original RIMA spare parts and spare parts provided by the authorized local gas representative shall be used in the flue gas outlet connections. Please read the instructions before connecting the flue.

Local gas distributors may have different directives, so obtain information from your local gas companies or their representatives

### 3.6.Electrical Connections

- Electrical connections shall be performed by authorized technicians
- The junction box, fuse, switches and sensors delivered are fully assembled and their functionality is tested.
- The main supply line and other auxiliary equipment (circulation pump, etc.) shall be connected by a qualified technician.
- Please inspect the electrical wiring diagram thoroughly before making any connections.
- Disconnect the main power line before any application. The fact that the On/Off switch is in the Off position does not necessarily mean that the power supply line is off.
- There is voltage at the boiler supply terminals even if the on/off switch is turned off.
- When connecting the boiler to the mains, a V-automat of 230V-6A with a minimum contact distance of at least 3 mm from the multi-pole switch shall be available and it shall certainly be fixed.
- The sensors shall be connected to the 24V terminals in accordance with the electrical diagrams provided.

### Connection Terminals

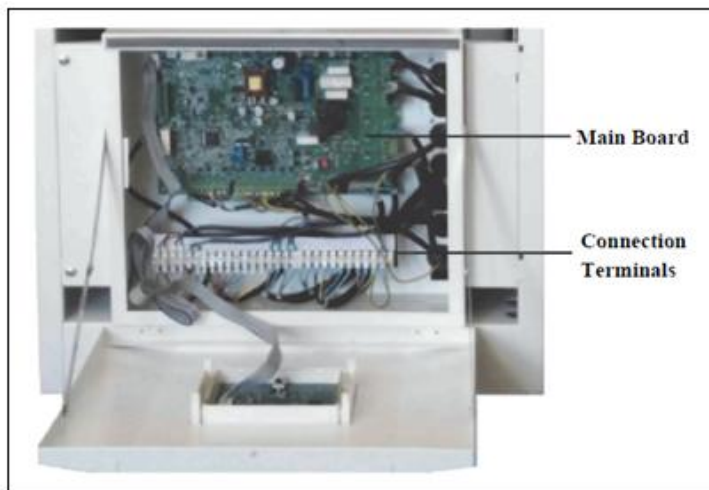

- During the commissioning, the boiler control performs an internal inspection for about 10 seconds
- The electrical values of the connected controls shall be suitable for the loads activated by the boiler control (e.g. controller, SDC, room thermostats...)
- The device shall be commissioned by RIMA authorized services. Disconnect the power supply to prevent electrical shock or equipment damage.
- The device is connected to the power network through a fixed connection. The electrical connection shall be permanently connected through a disconnecting device (cut-off switch, fuse) with a contact distance of at least 3 mm. Connection cable (flexible, 3x1.0 mm<sup>2</sup> max. 3x1.5 mm<sup>2</sup> TTR)

### 3.7.Ongas 300 Electrical Wiring Diagram

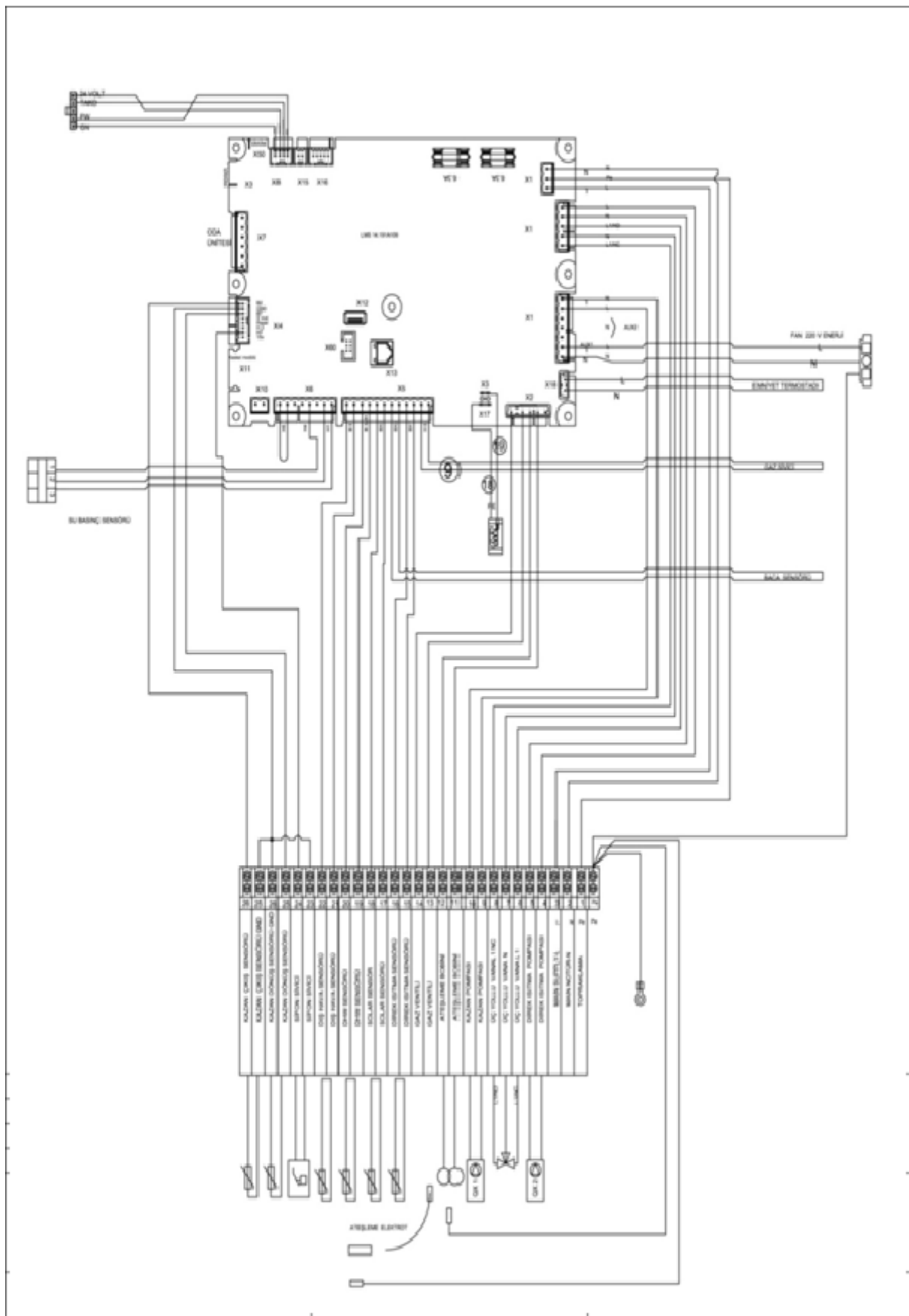

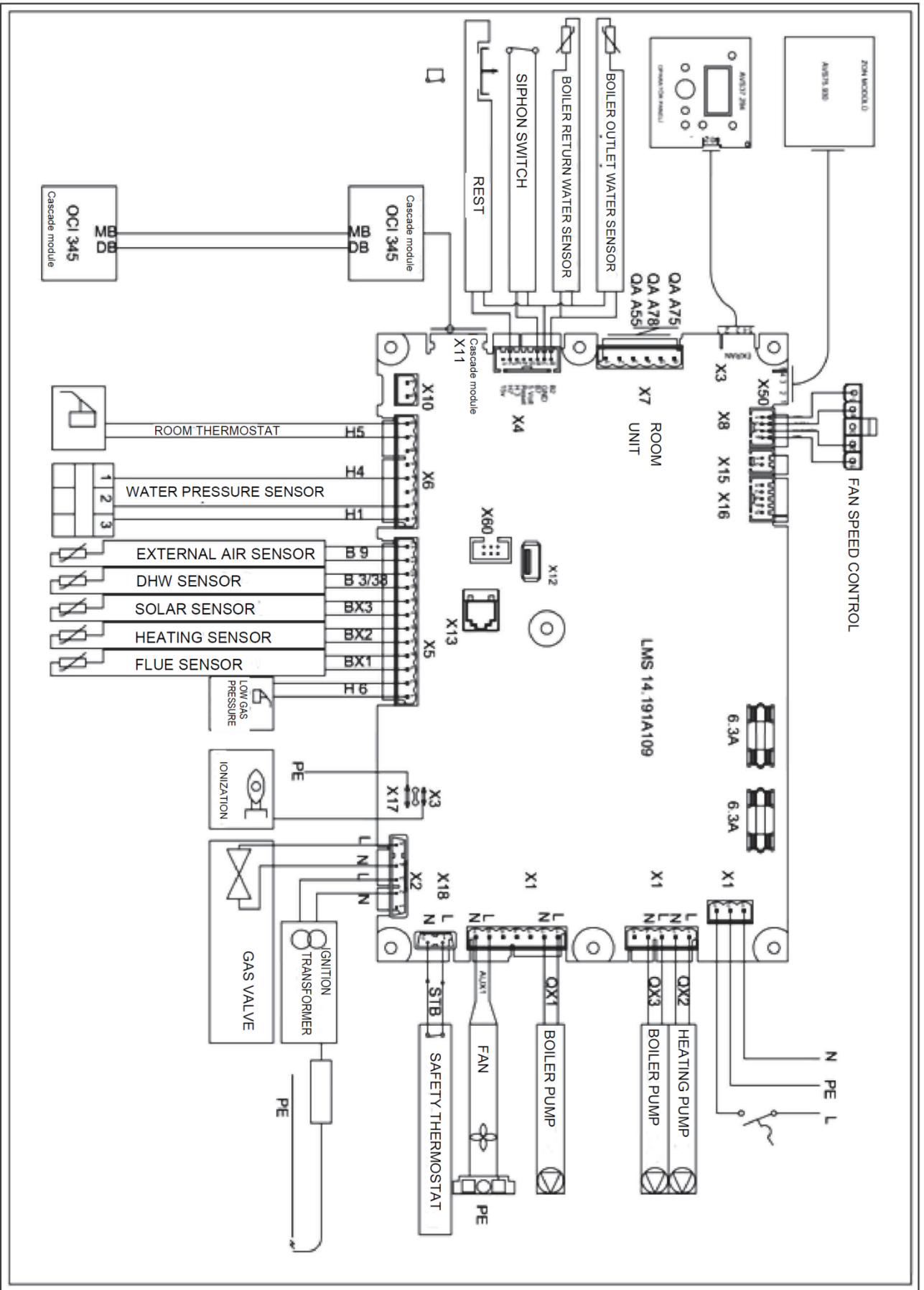

### 3.8 Commissioning

The following instructions shall be followed to operate the unit.

- Correct installation, electrical installation, and in case of wireless solutions, correct radio connection with all required external units are prioritized.
- Make all hardware-specific settings. Be very careful when following the instructions provided on the “Configuration” page.

Therefore, the respective operating levels given below shall be selected

- Press the OK button on the Operator unit or Room unit to switch to the programming mode.
- Press the info button (I) for at least 3 seconds and select the “Commissioning” operating level by rotating the adjustment knob to the + or - side and press the OK button. Perform the functional inspections as follows.
- Set the reduced outdoor temperature again (Operation page “Consumer Diagnostics”, from the operating line) “Reduced outdoor temperature”(operation line no: 8703)

**Functional Inspection:** The controller allows the performance of input-output tests in order to facilitate commissioning and fault monitoring operations. Inputs and outputs of the controller are inspected by these tests. Switch to the operation page “Input-output tests” to perform the tests, and then apply all the adjustment lines provided.

**Operating Status:** The current operating status may be checked from the “Status” section of the operating page.

**Diagnostics:** For detailed hardware diagnostics, check the “Heat source diagnostics” and “Consumer diagnostics” sections of the operating pages.

#### Main Units

LED OFF: No power supply

LED ON: Ready

LED flashing: Partial failure

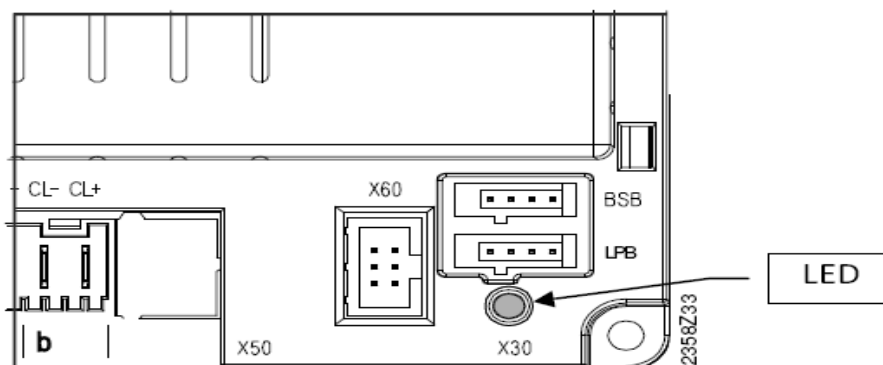



## 4.OPERATION OF THE CONTROL PANEL

### 4.1. Control Panel Display:

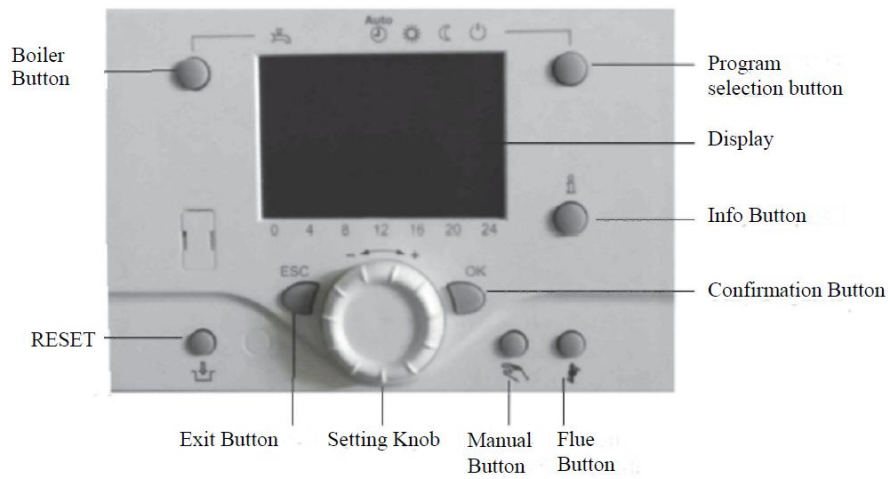



### 4.2.Application Modes:



**2.1.Selection of the Heating Mode Range:** This setting is used for switching between different operating modes. Selection is indicated by the line under the relevant symbol.





**2.1.1. Automatic Mode** **AUTO** : Automatic mode controls the room temperature as per the time schedule.

Features of the automatic mode:

- Time scheduled heating mode
- Heating settings as per heating programs “Heating at Comfort Level”  or “Economy setting point” 
- Protective functions are active
- Automatic summer/winter switching (ECO functions)

**2.1.2. Continuous operation**  or : Continuous operation ensures that the room temperature remains at the specified operating level.

 Heating at comfort level

 Heating at reduced value

### Features of the continuous operation:

- Heating mode without time schedule
- Protective functions are active
- 24-hour heating limit is not active at Automatic summer/winter switching (ECO functions) and Continuous operation with comfort level

**2.1.3. Protection  or Off:** Heating system is off during the operation of the protection mode, but protection against frost (freezing protection temperature) is active if there is no power error.

### Features of the protection mode:

- Heating off
- Temperature as per freezing protection
- Protective functions are active
- Automatic summer/winter switching (ECO functions) and automatic 24-hour heating limit are active

**2.2. Selection of the Winter Mode  :** Winter mode is selected using the Winter button. Selection is indicated by the setting bar under the relevant symbol.



**2.2.1. Winter Mode:** Winter mode allows the control of the room temperature as per the time schedule.

### Features of the winter mode:

- Manual winter mode
- Time scheduled winter mode
- Temperature setting determined as per “Comfort Winter Level”
- Protective functions are active
- Automatic summer/winter switching is active
- Summer compensation

**2.2.2 Freezing Protection:** When the water temperature of the heating circuit is dropped too much, the protection system integrated to the boiler is started. If the water temperature is below 4°C, the boiler is turned on. If the water temperature rises above 10°C, the boiler switches off and the heating circuit pump runs for a short period after that.

**3.3. Selection of DHW (Domestic hot water) heating mode:** The button indicated is used to switch  DHW heating mode on or off. Selection is indicated by the setting bar under the relevant symbol.

### **DHW heating mode**

- ON: DHW is heated as per the selected switching schedule.
- OFF: DHW heating is turned off. However, protective functions are active.



### DHW key

**i** Activation is performed by holding the DHW operating mode button on the room unit or operator for at least 3 seconds.

It can may be started in the following conditions:

- Operating mode is “Off”
- When switching between the operating modes are active as H1 or centrally (LPB),
- If all heating circuits are in vacation mode.

**2.4.Changing the Set Point of the Room Temperature:** Rotate the adjustment key to + or - direction to decrease or increase the **comfort value** 

**For reduced set point** 

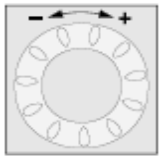

Press the OK button.

- Select “Heating circuit” in the operating page and
- Set the desired temperature value for economy.

After each setting operation, wait at least two hours for the room temperature to reach the specified level.

**2.5.Stand-by Button:** If the rooms shall not be used for a certain period of time, you can press the stand-by button to reduce the room temperature; this allows savings of thermal energy.

When the rooms shall be used again, press the stand-by button again to resume heating operation.



 Comfort heating set point

 Economy heating set point

The stand-by button is active during automatic operation only. The current selection shall be active until the next switching operation performed as per the selected heating program.

**2.6. Indicator Information:** You may display certain data by pressing the data button.

**2.7.Possible Indicators:** Some of the information lines listed below may not be displayed depending on the unit type, configuration, and operating status.

Indicator:

- Possible error messages
- Possible service messages
- Possible special mode messages

### 2.8. Other Indicators:

- Room temperature
- Minimum room temperature
- Boiler status
- Maximum room temperature
- Solar status
- Boiler water temperature
- Solid fuel boiler status
- Ambient temperature
- Auxiliary storage tank status
- Min. ambient temperature
- Swimming pool status
- Max. ambient temperature
- Time and date
- DHW temperature 1
- Customer services phone number
- Heating circuit 1 status
- Heating circuit 2 status
- Heating circuit P status
- DHW status

**2.9.Special Conditions:** In special conditions, one of the following symbols appears on the main display:

 **Error messages;** when this symbol is displayed, it indicates that an error has occurred in the unit.

Press the data button and read the detailed information.

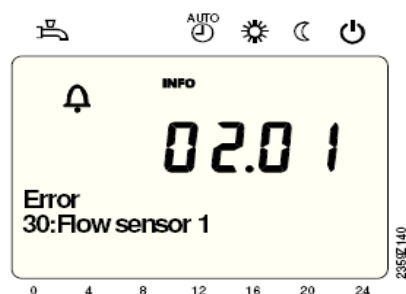

 **Maintenance and special operation;** when this symbol is displayed, a maintenance alarm is issued and it indicates that the unit has switched to the special mode. Press the data button and read the detailed information.

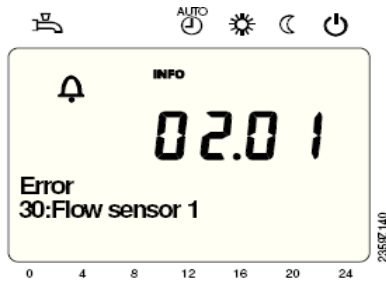

**Reset Function;** if resetting is permitted on the current operating line (end user/operating mode/heat engineer), the reset function for measurement devices and resettable parameters appears on the bottom line of the display.

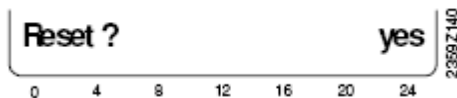

If manual operation is active, the relays are no longer supplied with power and their energy is cut off as per the control status, but they may be set to a predetermined manual operating status depending on their function.

In the control state, the power supplied to the energized burner relay may be cut off by the electronic temperature controller (TR).

**Setting a set point during manual operation;** after activating the manual control, a change shall be performed on the main indicator. Here, maintenance/special mode symbols  are displayed.

Press the info button to switch to the “Manual mode” data screen where settings may be performed.

**Flue Measurement (and maintenance/cleaning) Function;** performed after a short press on the flue cleaning button (max. 3 Seconds). This function provides the operating condition required for performing emission measurements.

## 2.10.SLT Test

SLT test (SLT = Safety Limit Thermostat) is performed after a long press (more than 3 seconds) on the button on the flue. The button shall be held pressed through whole test. Test shall be stopped if the button is released. SLT test is displayed on the screen.



Test shall be performed by a qualified team only as the temperature of the boiler water reaches the maximum level.

## 4.3. Programming







### 3.1.Principles of Setting

Settings that cannot be performed directly with the operating elements require programming. Individual settings in the form of operating pages and operating lines shall be created for this purpose. The following example shows how to set the date and time.

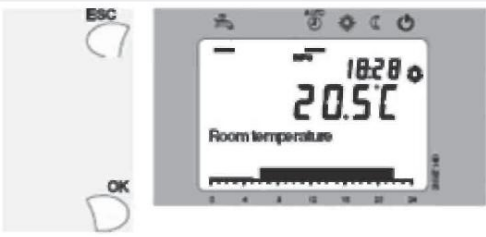
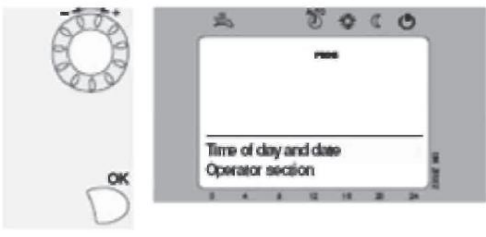
#### Example: “Setting the time and date”

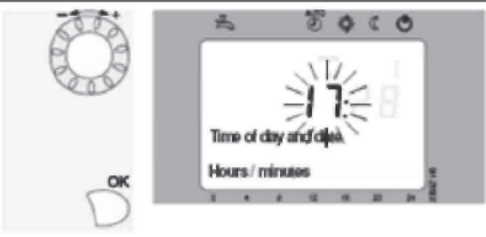
- Press ESC to go back in time settings; corrected values shall not be accepted.
- If no setting is performed within 8 minutes, the display automatically returns to the main screen.

- Operating lines may not be displayed depending on user levels, controller types, and the configuration performed.

Operation	Display Example	Identification
1		<p>Main display Press the ESC button if the main display is not displayed.</p> <p>Press OK</p>
2		<p>Some operating pages are displayed on the upper part of the display. Rotate the setting knob until the operating line hours/minutes are</p> <p>Press OK to confirm</p>
3		<p>First operating line of the operating page on the upper part of the display. <i>Time and time zone are displayed</i></p> <p>Press OK to confirm.</p>
4		<p>Time indicators flash Rotate the setting knob until the time zone is set.</p> <p>Press OK to confirm</p>
5		<p>Time indicators flash. Rotate the setting knob until the minutes and day is set.</p> <p>Press OK to confirm</p>
6		<p>Settings are recorded and the display becomes solid. You may make other settings or press the operating mode button to return to the main display after this time.</p>
7		<p>At this time, you may see the main display again.</p>



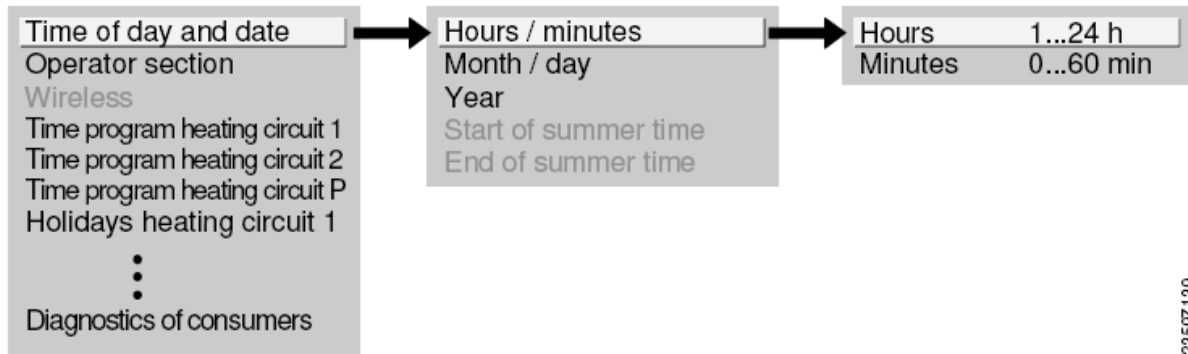



## Sample Menu Structure

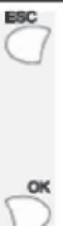
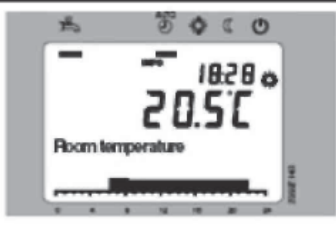

2350Z139

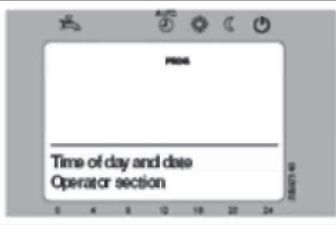
## 4.4. User Levels

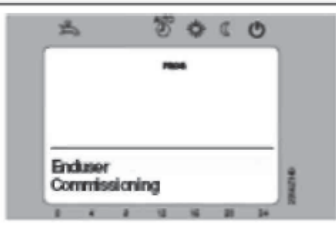
User levels allow only authorized user groups to make settings. To access the desired user level, perform the following steps;

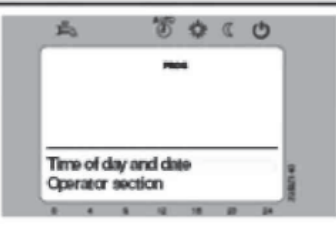
Operation	Display Example	Identification
<p>1</p> 		<p>Main display. Press the ESC button to return if the main display is not displayed.</p> <p>Press OK.</p>
<p>2</p> 		<p>This shows that you are at the end user level.</p> <p>Press INFO for 3 seconds.</p>
<p>3</p> 		<p>User selection is displayed. Rotate the setting knob until you reach the desired user level.</p> <p>Press OK to confirm</p>
		<p>This shows that you are at the desired user level.</p>

The password shall be entered to access the OEM level.

### Setting the “end-user” configuration

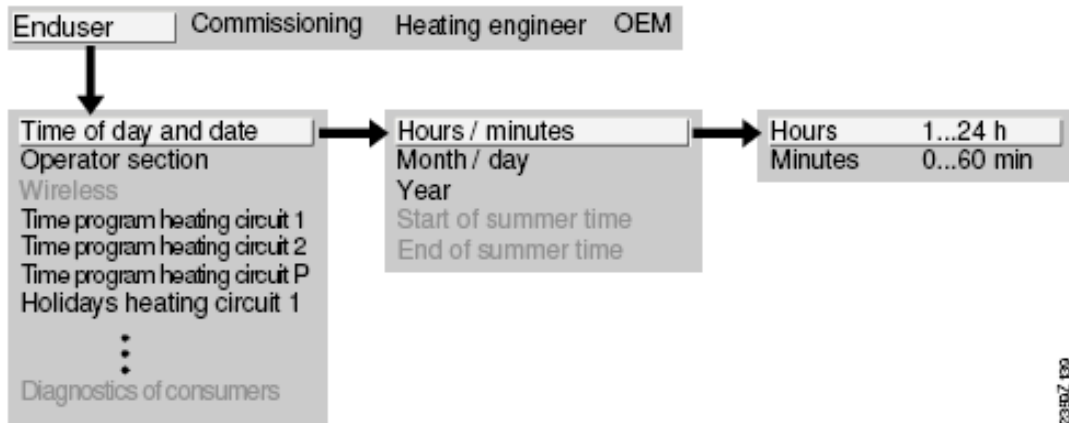

### User Menu and Line Numbers

- Date and time of the day (1-6)
- Operator unit (20-70)
- Wireless (120-140)
- Time schedule heating circuit 1 (500-516)
- Time schedule heating circuit 2 (520-536)
- Time schedule 3 (Pump circuit) (540-556)
- Time schedule 4 (Domestic hot water) (560-576)
- Time schedule 5 (600-616)
- Vacation schedule 1 (641-648)
- Vacation schedule 2 (651-658)
- Vacation schedule pump circuit (661-668)
- Heating circuit 1 (710-900)
- Heating circuit 2 (1010-1200)
- Heating circuit pump (1300-1500)
- Domestic hot water (1610-1680)
- Consumer circuit 1 (1859-1880)
- Consumer circuit 2 (1909-1930)
- Swimming pool circuit (1959-1980)
- Swimming pool (2055-2080)
- System pump (2110-2150)
- Boiler (2203-2663)
- Cascade (3510-3590)
- Auxiliary heat source (3690)
- Solar power (3810-3887)
- Solid fuel boiler (4102-4170)
- Auxiliary tank (4720-4813)
- Domestic hot water tank (5010-5151)
- Instant water heating (5420-5550)
- Configuration (5710-6236)
- LPB (6600-6650)
- Failure (6700-6999)
- Maintenance/special operation (7040-7254)
- Relay test (7700-7952)



- Status (8000-8011)
- Cascade diagnostics (8100-8150)
- Heat generation diagnostics (8304-8570)
- Heat consumption diagnostics (8700-9058)
- Burner control (9500-9652)

**“Heat engineer” configuration setting**

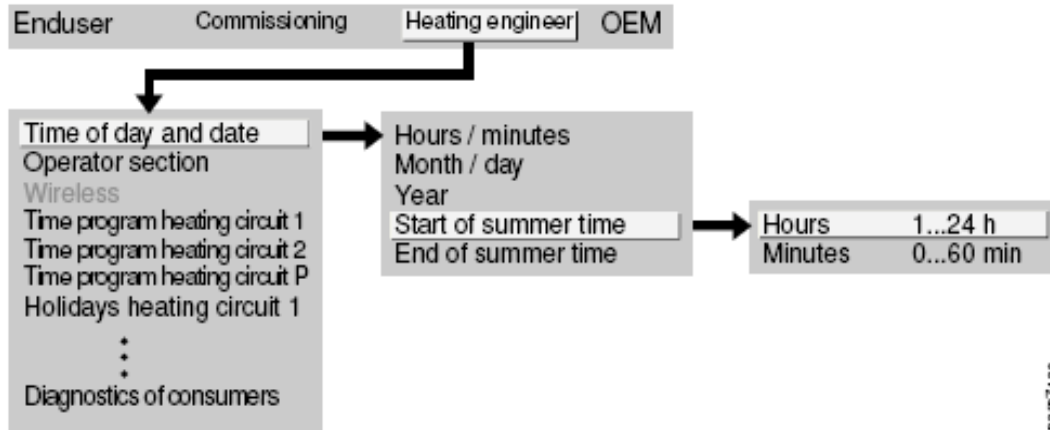

2390Z139

**Entering**

**the Engineer Level**

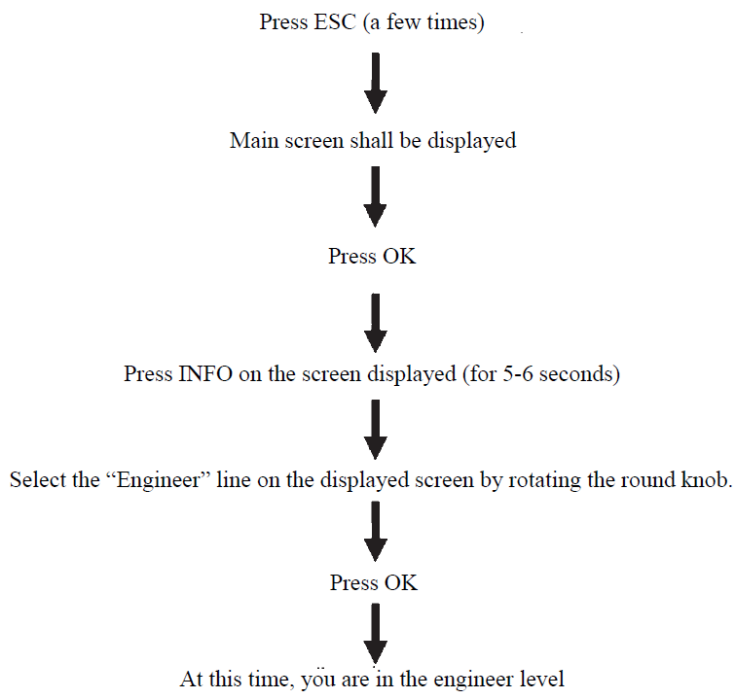

## 4.5. Operation of the Control Panel Accessories (QAA75.. / QAA78... / AVS37..)

### Operating Elements



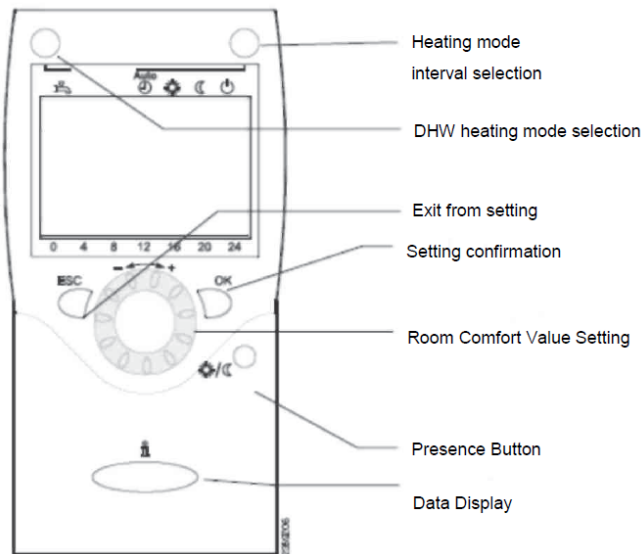

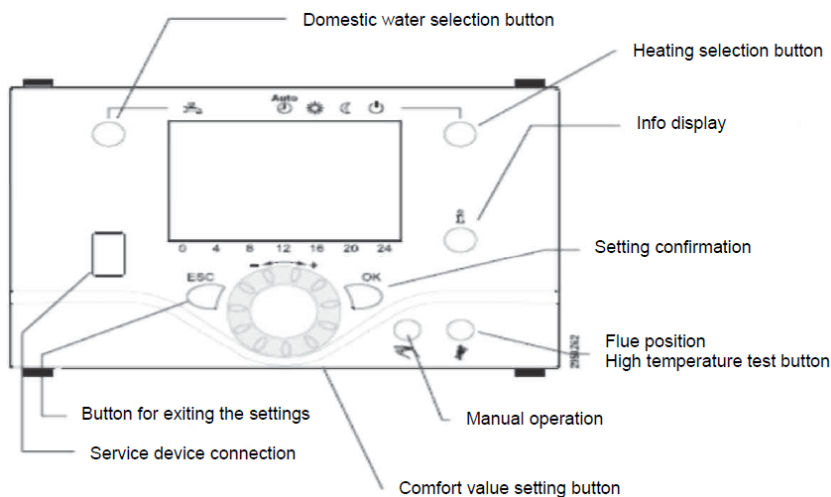

#### Room Unit (Optional)



#### Operator Unit



### Display Options

-  Heating at comfort level - Information level active
-  Heating at economy level - Programming active
-  Heating at Freezing Protection value - Heating provisionally OFF
-  Starting sequence – Please wait - Vacation function active
-  Replace the battery - Circuit heating
-  Burner active (gas/liquid heater only)



In addition, authorized services shall measure the hardness value of the installation water while commissioning the boiler and condition the water by adding a “chemical additive” in accordance with this hardness value. The chemical protective additive sample for delaying the calcification is sent free of charge by the manufacturer in the packaging of the boiler. Then, in case of addition of fresh water to installation water; the chemical additive shall be requested from the manufacturer for a fee.

(If water level in the installation is reduced, fresh water to be added to the installation shall be supplied together with chemical additives. Chemical additive is sold in our dealers in 5-liter packages.)

**Sediment:** Particles that cause sediment in the water piping accumulate on the heat transfer surfaces in the form of a sludge layer where the flow of water slows down, thus preventing circulation of water and slowing the heat transfer.

A sediment trap shall be used instead of sieve and cartridge type filters, to remove materials that cause sediment. Water cannot pass through these filters when the surfaces of the sieve/cartridge type filters are filled with sediment in the water, and this causes the boiler to operate without water, overheat and thus causes calcification. In sediment traps, however, the sediment settles in the form of sludge and water continues to pass from the top. The sediment traps are required to be cleaned periodically; but cleaning periods are much longer than sieve/cartridge type filters.

Instructions have been issued by various organizations on the quality of the water used in the heating and boiler systems; e.g. VDI Directive 2035, DIN EN 14868 Standard of German Norm Institute, Data Sheets VdTUV 1453 and 1466, Commission for Steam Boilers TRD611...

According to these instructions, the following reference values apply to prevent excessive build-up of lime (calcium carbonate) in heating systems with operating temperatures up to 100°C;

VDI Directive 2035 “Prevention of damage to hot water heating systems - formation of boiler stones in domestic water and hot water heating systems” (also refer to the original text of the regulation):

Total heating capacity (kW)	Total hardness (°F)
≤ 50	No condition
> 50 ≤ 200	≤ 20
> 200 ≤ 600	≤ 15
> 600	< 0.2

In cases where these conditions are not met, the filling and additional water of the boilers shall be softened. The cost of water treatment is in any case less than the cost of the repairing of the damages in the boiler system. Damages caused by corrosion and calcification are not covered by the warranty.

**5.1.2. Water pressure:** In high buildings, the pressure may exceed 6 bar, particularly when the water is heated, and cause the relief valve on the boiler to open. In such a case, water with the lost amount

shall be added to the installation. This reduces the effect of water conditioning previously performed, causing calcification or corrosion by oxygen.

According to our experience, the dynamic installation pressure in the hot state reaches the maximum acceptable value for the boiler when the height of the building reaches 40 meters. In all tall buildings that exceed 14 floors from the boiler room, the boiler water circuit and the radiator water circuit shall be separated from each other by using a **plate heat exchanger**.



Damages caused by the opening the relief valve are not covered by the warranty.

**5.1.3. Flow rate of the water:** In case of inadequate water circulation in the boiler, the temperature on the surfaces of the fins close to the burner increases. High temperature is one of conditions that accelerate the settlement of lime. Excessively high flow rate also causes wear due to erosion.

**We recommend selecting Delta T: 12-15 instead of 20.**

You may find the energy efficient pump models recommended for Ongas 300 floor and wall type boilers in the table below. When using equivalent pumps, the flow rate, head and diameter of the specified pumps shall be taken considered. Usage of steps pumps is not recommended.

Boiler Models	Grundfos	Wilo	Pump Diameters
Ongas 303	Upml 25/105	Yonos Para 25/7	DN 25
Ongas 304	Upml 32/105	Yonos Para 32/10	DN 32
Ongas 304 plus	Upmxi 32/125	Yonos Para 32/10	DN 32
Ongas 305	Upmxi 32/125	Yonos Para 32/10	DN 32
Ongas 306	Magna 40/120	Yonos Para 40/12	DN 40
Ongas 307	Magna 40/120	Yonos Para 40/12	DN 40

**Systems with open expansion tanks:** In systems with open expansion tanks, the level of installation water is constantly reduced due to evaporation and thus fresh water shall be supplied to the installation continuously. This means that both new lime and oxygen, which may cause corrosion, shall enter the installation. Therefore, **boilers shall not be used with open expansion tank systems**. If it shall be used with an open expansion tank system, a plate heat exchanger shall be placed between boiler and heating installation, and it shall be ensured that boiler water and installation water does not mix with each other.

**Transformation of the old heating installation:** In such installations, sediments and residues from old boilers, radiators and pipes may be filled into the boiler, causing clogging of the boiler or very low flow rate of water. This causes the temperature of the boiler heat exchanger to increase and consequently causes cracks on the fins. Thus, if the boilers shall be used in the old heating installation, the installation shall be washed very well; and we strongly recommend the use of a plate heat exchanger instead of the balance vessel between the boiler and the installation.

## 5.2. Discharging of the Condensate

Drain the condensate directly into the drainage with a pipe. Due to the acidity level of this water (pH 2-5) use pipes made of plastic material only for the (R 3/4") connection pipe. Condensate shall be drained into a groove that opens out to the exterior due to the risk of freezing.

## 5.3. Instructions for the Adjustment of Gas Ratio



A fire or explosion hazard may cause damage, serious injuries, or death.

### 5.3.1. Gas Leak Test

- The gas leak test shall only be carried out by an authorized service or an expert.
- Test all pipe connections in the flow path of the gas control unit with a rich mixture of soap and water. The formation of bubbles indicates the presence of a gas leak.
- If you observe a gas leak, tighten the pipe fitting.
- Stand in a safe place to prevent injury from gas leaks, which could cause a flare back at the inlet of the unit when the main burner is ignited. Ignite the main burner.
- While the main burner is operated, test all pipe joints (including adapters), and inlets and outlets of the gas control unit with a rich mixture of soap and water.
- If you observe another gas leak, tighten the adapter bolts, pipe joints and connections.
- If it is not possible to stop the gas leak, replace the part.

Perform gas leak inspections on the gas control unit at any time during operation. Keep the mixture of soap and water away from electrical connections. Disconnect the main line to prevent electrical shocks and damage to the equipment. Wiring shall comply with local regulations. Always follow the instructions of the manufacturer of the unit. Check if the type number is correct for the application before installation or replacement. Make sure that there is no gas left in the combustion chamber before starting the boiler. When the installation is complete, perform a final inspection. The boiler may be locked during the commissioning; press the reset button. Under normal circumstances, service or maintenance shall not be required.

### 5.3.2. Adjustment of the Gas Ratio

Adjustments of gas ratio shall be performed separately at full modulation speed (100%) and at the minimum modulation speed (0%) of the boiler. The boiler shall be set to test mode for the adjustment of modulation.

Press the Operating Mode Switching button on the control panel of the boiler for 3-5 seconds, as indicated by the red arrow, to put the boiler into test mode. When you press the "info" button again after waiting for 2-3 seconds, the display shall indicate (50%) and the boiler modulation speed shall be displayed. When you press OK when prompted "Adjustment?", this value starts to flash and it can be adjusted between 0-100% using the adjustment button. At this time, the flue gas analyzer is prepared for measurement and the measuring probe is inserted into the flue through the gas measuring hole.





At this time, the flue gas analyzer is prepared for measurement and the measuring probe is inserted into the flue through the gas measuring hole. Gas valve adjustment process performed with the appropriate tool is continued until the emission values provided in the table below are reached;



Boiler model	69 kw	100 kw	115 kw	125 kw	155 kw	190 kw
CO <sub>2</sub> (Pmax)	9.2	9.6	9.3	9.3	9.4	9.7
CO <sub>2</sub> (Pmin)	9.0	9.1	9.1	9.1	9.1	9.2

**190 kw (Honeywell VR420 Series Gas Valve)**



The point shown in the photo is used to set the maximum speed. Remove the plastic protection cap with a thin screwdriver bit, if required, and perform the adjustment with the appropriate tool.

The point shown in the photo is used to set the minimum speed.

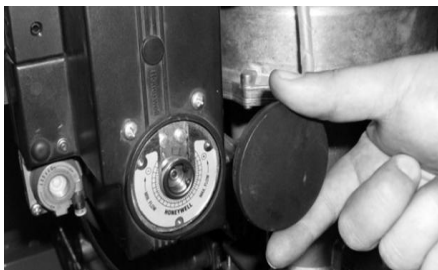

**69 kw& 100 kw& 115 kw& 125 kw&155kw (DUNGS GB-ND 057 Gas Valve)**

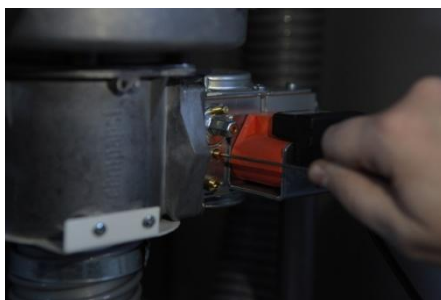

The point shown in the photo is used to set the maximum speed.

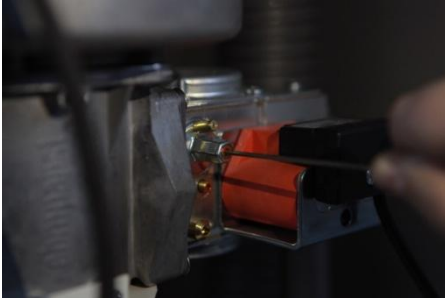

The point shown in the photo is used to set the minimum speed.

### 155 kw&190 kw (Honeywell VR420 Series Gas Valve)

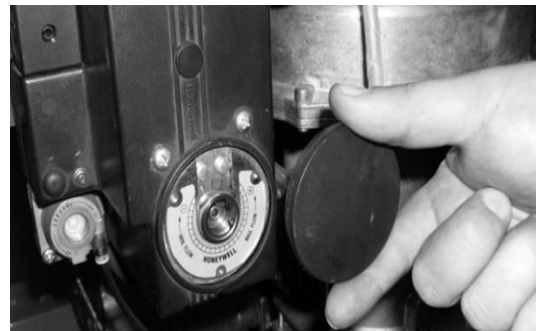
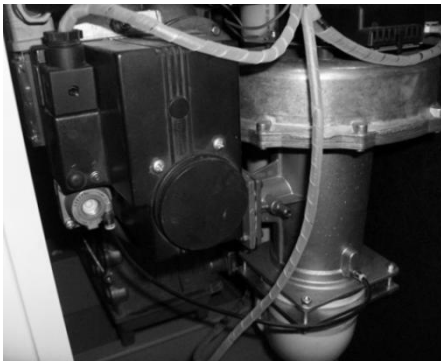

For EBM

The point shown in the photo is used to set the maximum speed. Remove the plastic protection cap with a thin screwdriver bit, if required, and perform the adjustment with the appropriate tool.

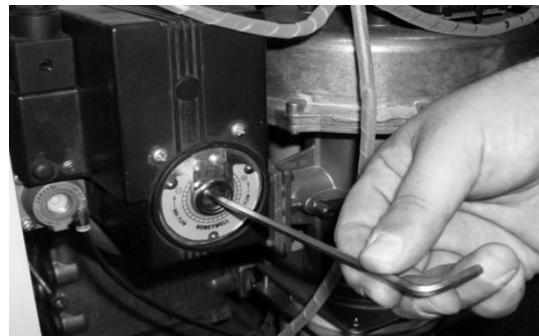

The point shown in the photo is used to set the minimum speed.





**100 kw& 115 kw&125 kw (Honeywell VR4615 Series Gas Valve)**

The point shown in the photo is used to set the maximum speed.

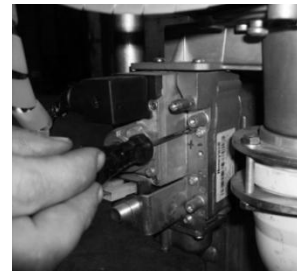

The point shown in the photo is used to set the minimum speed.

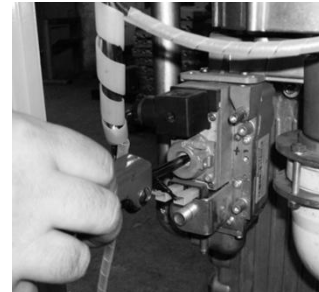

**69 kw (Honeywell VK4115 Series Gas Valve)**

The point shown in the photo is used to set the maximum speed.

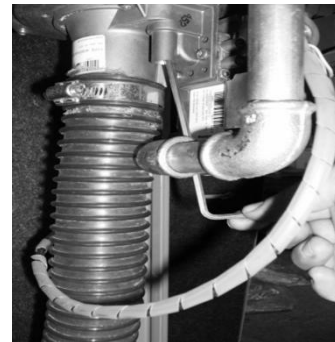

The point shown in the photo is used to set the minimum speed.



## 5.4.Flue Connections

The boiler is designed for the following flue configurations:

**Type B23:** The boiler is designed to be connected to an open flue hole that shall exit vertically from the roof. The combustion air is directly taken from the room where the boiler is installed. In connection type B23, the room shall comply with the same installation requirements as approved for open flue boilers. The flue shall also comply with the applicable laws.

**Type C63:** Closed room application supported by terminals or special ducts for air supply and flue gas discharge.

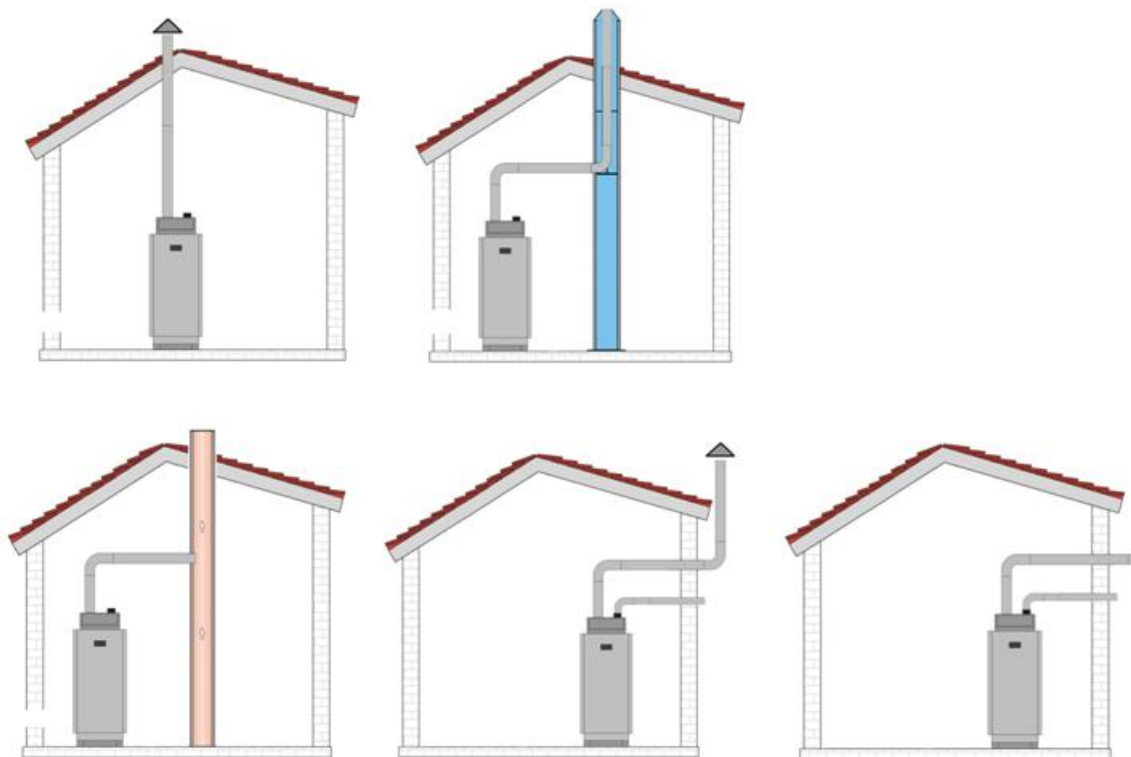

### 5.4.1.Installation Examples

- The flue system shall be installed in accordance with local and international standards (EN-13384-1-2).
- The material for flue outlet shall only be a material that is resistant to combustion products; and as a rule it shall be made of stainless steel or plastic.
- Flue connections shall be performed by authorized persons.
- Connect the boiler to the flue using pipes made of stainless steel or plastic material with a structure and an internal diameter (diameters may vary depending on the boiler models) that are resistant to high temperatures ( $> 120^{\circ}\text{C}$ ), chemical effects of flue gases, condensate and normal mechanical stresses that shall be experienced in time.
- Use a flue connection that can be removed at any time considering maintenance applications.
- Horizontal flue passages shall have a minimum inclination of  $3^{\circ}$  in the direction of the boiler.

- Joints and auxiliary flue accessories made of plastic for cascade and individual installations shall be gas and water proof; and they shall also allow horizontal passages (min. 5 cm discharge per meter) that are inclined towards the boiler for discharges that do not contain any condensate. Flue gas discharges longer than 2 meters shall be supported independently and they shall not lean upon the boiler.
- The flue outlet may only be terminated with a reduction cone and a bird cover.

#### 5.4.2.Flue Installation for ONGAS 300 / W Series Wall Type Boilers

Contents of the ONGAS 300/W Condensing Boiler Vertical Flue Set: 75 cm terminal, bird cover, flue ring

Contents of the ONGAS 300/W Condensing Boiler Horizontal Flue Set: 75 cm terminal, bird cover, flue ring, 90 degrees elbow

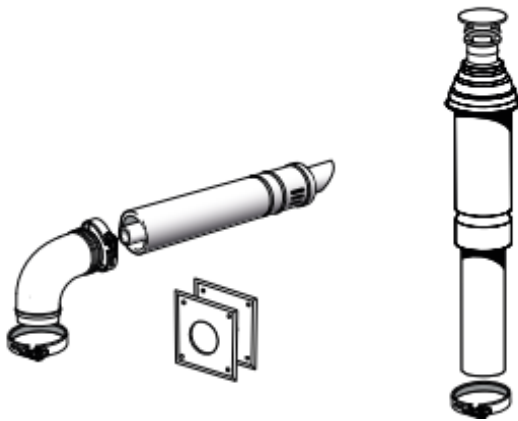

**All horizontal flue gas pipes shall be installed at an angle of 3° to allow the condensate to flow back.**

A clearance between the flue gas pipes and the inner wall shall be provided. Flue length is calculated according to the maximum pressure values given below.

Models		Ongas 303w	Ongas 304w	Ongas 304w plus	Ongas 305w	Ongas 306w	Ongas 307w
<b>Boiler Flue Diameters</b>	mm	80	100	101	115	127	150
<b>Maximum Pressures</b>	Pa	260	260	260	180	210	190
<b>Max. Flue Distances</b>	m	15	25	25	17	27	37
<b>Losses</b>		At each 90 degrees elbow: 2 m		At each 45 degrees elbow: 1 m		At each 1 m terminal: 1 m	



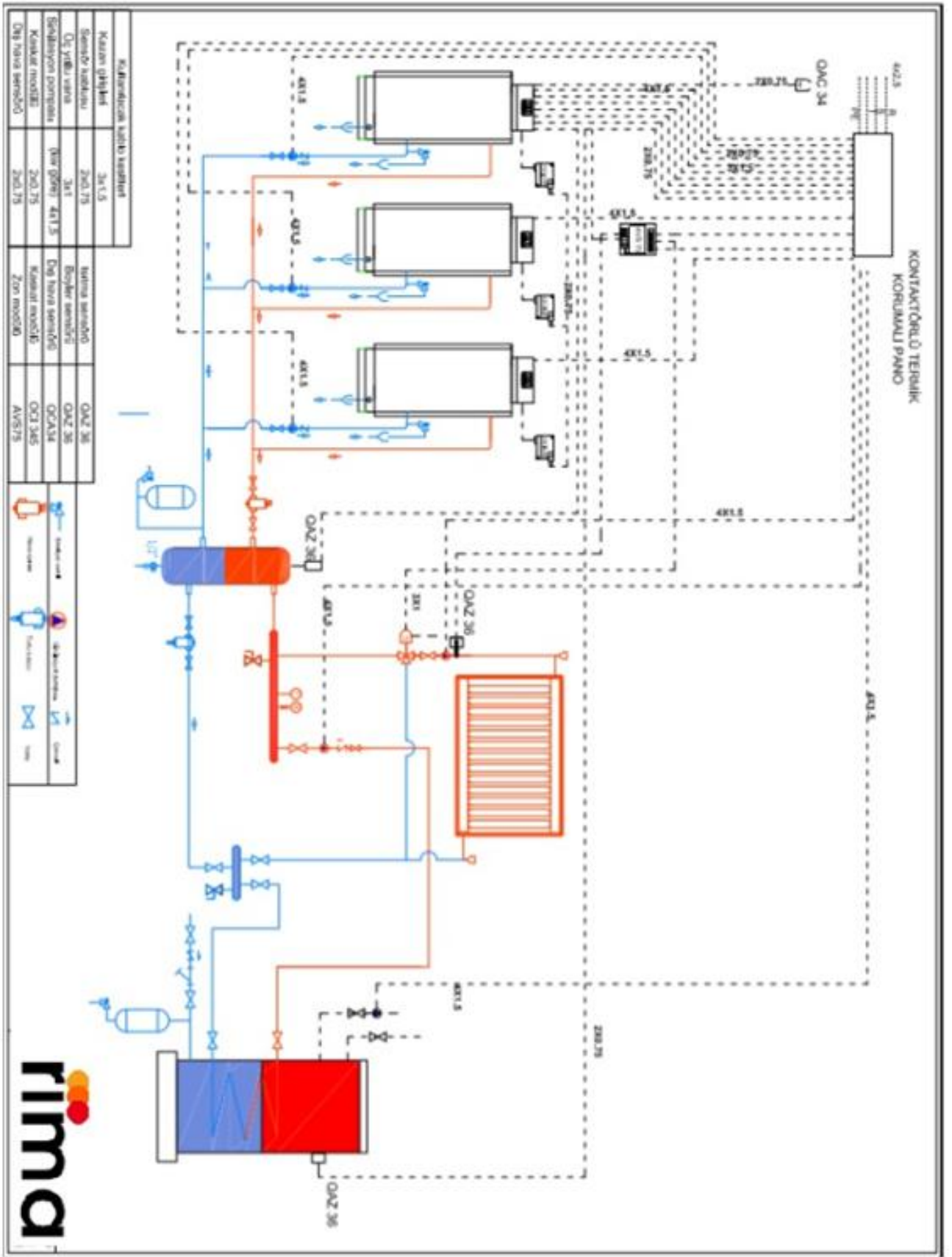

## **6.ERROR CODES**

<b>Error code</b>	<b>LPB code</b>	<b>Error Definition</b>	<b>Priority</b>
10		Ambient temperature sensor error	6
20		boiler temperature sensor 1 error	6
20		boiler temperature sensor 1 error	9
25		boiler temperature solid fuel sensor error	6
26		Common flow temperature sensor error	6
28		Flue gas temperature sensor error	6
28		Flue gas temperature sensor error	9
30		Flow temperature sensor 1 error	6
31		Flow temperature cooling sensor 1 error	6
32		Flow temperature sensor 2 error	6
38		Flow temperature main control unit sensor error	6
40		Return temperature sensor 1 error	6
40		Return temperature sensor 1 error	9
46		Cascade return temperature sensor 1 error	6
47		Common return temperature sensor 1 error	6
50		Domestic water temperature sensor 1 error	6
52		Domestic water temperature sensor 2 error	6
54		Flow temperature domestic water sensor error	6
57		Domestic water circulation sensor error	6
60		Room temperature sensor 1 error	6
65		Room temperature sensor 2 error	6
68		Room temperature sensor 3 error	6
70		Storage tank temperature 1 (top) sensor error	6

<b>Error code</b>	<b>LPB code</b>	<b>Error Definition</b>	<b>Priority</b>
71		Storage tank temperature 2 (bottom) sensor error	6
72		Storage tank temperature 3 (center) sensor error	6
73		Collector temperature sensor 1 error	6
78		Water pressure sensor error	6
78		Water pressure sensor error	9
82		LPB address conflict	3
83		BSB cable cross sectional connection not available	8
84		BSB cable address conflict	3
85		BSBKF communication error	8
91		Excess data operation at EEPROM	3
91		Excess data operation at EEPROM	6
91		Excess data operation at EEPROM	9
98		Auxiliary module 1 error	8
99		Auxiliary module 2 error	8
100		2 main timing time	3
102		Main timing time (without redundancy)	3
103		Connection error	8
105		Maintenance message	5
109		boiler control temperature	6
109		boiler control temperature	9
110		STB (SLT) lock	6
110		STB (SLT) lock	9
111		Closing of temperature limiting safety	8
117		Water pressure too high	6

<b>Error code</b>	<b>LPB code</b>	<b>Error Definition</b>	<b>Priority</b>
117		Water pressure too high	9
118		Water pressure too low	6
118		Water pressure too low	9
119		Water pressure switch deactivated	6
119		Water pressure switch deactivated	9
121		Heating circuit 1 could not reach the flow temperature	6
122		Heating circuit 2 could not reach the flow temperature	6
125		Maximum boiler temperature exceeded	9
126		Domestic water filling temperature not reached	6
127		Domestic water legionella temperature not reached	6
128		Flame loss during operation	6
128		Flame loss during operation	9
129		Incorrect air supply	6
129		Incorrect air supply	9
130		Flue gas temperature limit exceeded	6
130		Flue gas temperature limit exceeded	9
132		Gas pressure switch safety turned off	6
133		Flame generation safety period exceeded	6
133		Flame generation safety period exceeded	9
146		Configuration error sensor / control elements	3
151		LMS14... error, internal	3
151		LMS14... error, internal	6
151		LMS14... error, internal	9
152		Parameter error	3



<b>Error code</b>	<b>LPB code</b>	<b>Error Definition</b>	<b>Priority</b>
152		Parameter error	9
153		Unit locked manually	9
160		Fan speed threshold not reached	9
162		Air pressure switch does not turn off	9
164		Flow / pressure switch, heating circuit error	6
164		Flow / pressure switch, heating circuit error	9
166		Air pressure switch error, it does not open	9
169		Sitherm Prosystem error	3
169		Sitherm Prosystem error	6
169		Sitherm Prosystem error	9
170		Water pressure sensor error, first side	6
170		Water pressure sensor error, first side	9
171		Alarm connection 1 active	6
172		Alarm connection 2 active	6
173		Alarm connection 3 active	6
174		Alarm connection 4 active	6
176		Water pressure 2 too high	6
176		Water pressure 2 too high	9
177		Water pressure 2 too low	6
177		Water pressure 2 too low	9
178		Temperature limiting heating circuit 1	3
179		Temperature limiting heating circuit 2	3
183		Unit is parameter mode	6
183		Unit is parameter mode	9

<b>Error code</b>	<b>LPB code</b>	<b>Error Definition</b>	<b>Priority</b>
195		Max. refilling period per filling operation is exceeded	6
195		Max. refilling period per filling operation is exceeded	9
196		Max. refilling period per week is exceeded	6
196		Max. refilling period per week is exceeded	9
209		Heating circuit error	3
209		Heating circuit error	6
214		Motor monitoring	6
215		Fan air mixing valve error	9
216		boiler error	6
216		boiler error	9
217		Sensor error	3
217		Sensor error	6
217		Sensor error	9
218		pressure control	6
218		pressure control	9
241		efficiency measurement flow sensor error	6
242		efficiency measurement return sensor error	6
243		Pool sensor error	6
260	217	Flow temperature sensor 3 error	3
270	215	Temperature difference heat exchanger too high	9
317	214	External mains voltage permissible range	6
320	217	Domestic water filling temperature sensor error	6
321	217	Domestic water ambient temperature sensor error	6
322	218	Water pressure 3 too high	6

<b>Error code</b>	<b>LPB code</b>	<b>Error Definition</b>	<b>Priority</b>
322	218	Water pressure 3 too high	9
323	218	Water pressure 3 too high	6
323	218	Water pressure 3 too high	9
324	146	BX inlet identical sensors	3
325	146	BX inlet/auxiliary module identical sensors	3
326	146	BX inlet mixture assembly identical sensors	3
327	146	Auxiliary module identical function	3
328	146	Mixture assembly identical function	3
329	146	Auxiliary module/mixture assembly identical function	3
330	146	BX1 sensor inlet no function	3
33L	146	BX2 sensor inlet no function	3
332	146	BX3 sensor inlet no function	3
333	146	BX4 sensor inlet no function	3
335	146	BX21 sensor inlet no function	3
336	146	BX22 sensor inlet no function	3
339	146	Collector pump Q5 missing	3
340	146	Collector pump Q16 missing	3
341	146	Collector sensor B6 missing	3
342	146	Solar charge domestic water sensor B31 missing	3
343	146	Solar connection missing	3
344	146	Solar control element buffer K8 missing	3
345	146	Solar control element pool K18 missing	3
346	146	Solid fuel boiler pump Q 10 missing	3
347	146	Solid fuel boiler comparison sensor missing	3

<b>Error code</b>	<b>LPB code</b>	<b>Error Definition</b>	<b>Priority</b>
348	146	Solid fuel boiler address error	3
349	146	Balance tank return valve Y15 missing	3
350	146	Balance tank address error	3
351	146	Main control unit system pump address error	3
352	146	Pressureless height address error	3
353	146	Cascade winter sensor B10 missing	3
371	209	Flow temperature heating circuit 3	6
372	209	Temperature limiting heating circuit 2	3
373	103	Auxiliary module 3	8
374	169	Sitherm Pro calculation	6
374	169	Sitherm Pro calculation	9
375	169	BV stepper motor	9
376	169	Expansion test limit value	3
376	169	Expansion test limit value	6
376	169	Expansion test limit value	9
377	169	Expansion test prevented	9
378	151	Internal repetition	9
382	129	Repetition rate	9
384	151	Secondary light	6
384	151	Secondary light	9
385	151	Mains low voltage	9
386	129	Fan speed tolerance	6
386	129	Fan speed tolerance	9

<b>Error code</b>	<b>LPB code</b>	<b>Error Definition</b>	<b>Priority</b>
387	129	Air pressure tolerance	6
387	129	Air pressure tolerance	9
388	146	Domestic water sensor no function	3
426	151	Flue gas damper feedback	9
427	152	Flue gas damper configuration	3
429	218	Dynamic water pressure too high	6
429	218	Dynamic water pressure too high	9
430	218	Dynamic water pressure too low	6
430	218	Dynamic water pressure too low	9
431	217	Heat exchanger main sensor	6
431	217	Heat exchanger main sensor	9
432	151	Grounding function not connected	9
433	216	Heat exchanger main temperature too high	6
433	216	Heat exchanger main temperature too high	9

## **7.CLEANING, MAINTENANCE AND REPLACEMENT OF THE BODY**

Periodical maintenances of the boiler shall be performed regularly. Otherwise this shall cause a decrease in the efficiency of the boiler and an increase in the fuel consumption.

For maintenance, repair or cleaning operations that may be carried by the consumer, he/she may only clean the room and clean the exterior of the unit with a damp (i.e., not wet) cloth. Any other issues are described in the maintenance and repair section.

- The power shall be disconnected from the mains switch for maintenance and cleaning operations.
- Original spare parts recommended and provided by RIMA shall always be used for maintenance and repair operations.
- Boiler maintenance is required to keep boiler efficiency constantly high, to prevent any possible failures in advance and to extend the service life of the boiler.
- Periodical and annual maintenances of the boiler shall be performed regularly.
- Repair and maintenance operations of ONGAS 300/W series boilers require expertise. This guide explains

the operation and maintenance procedures that shall be performed by the user. Other than these operations, the user or any person without the expertise shall not temper with any part or the settings of the boiler for reasons such as operating or maintaining, etc.

During the annual use of the boilers, particulate contamination may occur on the fresh air suction line, on the surface of the fins and on the condensate container and siphon as a result of combustion of the natural gas. Moreover, parts such as the return filter shall be inspected at least once (1) a year and shall only be cleaned by the authorized service.

Consider the following issues during the annual inspection of the boilers:

- inspection of the boiler's combustion system (fan, venturi and burner)
- inspection of the ignition electrode
- inspection of leaks (water, gas and flue gas)
- inspection of water pressure
- inspection of sections such as siphon and heat exchanger

Disconnect the main line, turn off the main gas valve and allow the boiler to cool before starting to work on the boiler.

When the body shall be replaced, the red securing bolt shall be removed and the body shall be lifted up. Then, the body shall be separated from the rear metal sheet. The new body shall be installed with the same procedure.

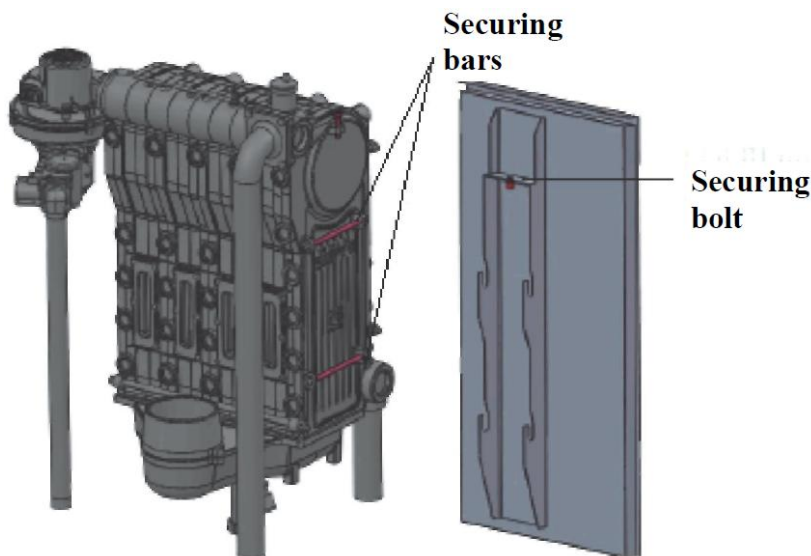

### 7.1. Inspection of the Combustion System

It shall be inspected by operations such as the measurement of the O<sub>2</sub>/CO<sub>2</sub> ratio from the measurement test point at the flue gas outlet with an analyzer. The boiler shall be operated at a temperature of about 70°C for this purpose. The measurements shall match the values for the gas ratio adjustment. And the flue gas temperature may be measured at the test nipple measuring point in the flue. If the flue gas temperature exceeds the return water temperature by more than 30°C, this may indicate that the heat exchanger is contaminated. It shall always be inspected and cleaned properly.

## 7.2. Cleaning of the Modulated Fan, Venturi and the Burner



Remove the electrical connections from the fan, gas valve and the electrodes.

1. Remove the bolts on the exterior of the burner.
2. Clean the Premix burner with an air gun (the distance between the nozzle and burner shall be about 1 cm and the pressure of the compressed air shall be 2 – 4 bar).
3. Remove the dusts on the fan and the burner.
4. Clean the venturi pipe with a plastic brush and air.
5. Install all parts you have removed again; check the position of the gasket plate between the fan and venturi is correct.



## 7.3. Inspection of the Electrodes

Inspect the setting of the ignition electrode (between 3 and 3,5 mm) and replace the electrode if required (together with the gasket). Also, inspect the electrode porcelain considering thin cracks that may allow leakage of flames on it.

## 8. WARRANTY AND COMMISSIONING

### Warranty Conditions

- 1) Warranty period starts with the delivery date of the goods. **Warranty period for condensing boilers is two (2) years.**
- 2) The goods are under warranty cover as a whole including all of their parts.
- 3) In the event that the goods are found to be defective, the consumer shall have the right to ask for the implementation of one of his/her rights specified in Article 11 of the Law No. 6502 on Consumer Protection: **a) Returning from the contract, b) Requesting a discount from the sales price, c) Requesting free repair, d) Requesting the replacement of the sold goods with an undamaged equivalent.**
- 4) If the consumer chooses **the right for free repair amongst these rights**, the seller is obliged to repair or have the product repaired without charging any fee under the name of labor cost, replacement part cost or any other name. The consumer may also exercise the right for free repair against the manufacturer or importer, too. The seller, manufacturer and importer are jointly responsible for exercising of this right by the consumer.
- 5) If the consumer uses the **right to repair free of charge**, the consumer may request **the return of price of the goods, price reduction at the ratio of the defect or the replacement of the goods with an equivalent free of defect** from the seller in the following cases;
  - Repeated failure of the goods within the warranty period,
  - Exceeding of the maximum time allowed for repair,

- In the event that repair is not possible is determined by the authorized service station, seller, manufacturer or importer with a report. The seller is not allowed to reject the request of the consumer. The seller, the manufacturer and the importer are jointly liable if this request is not fulfilled

6) The repair period of the goods shall not exceed 20 working days. This period starts from the date of notification of the failure of the goods to the authorized service station or the seller if it is within the warranty period, and starts from the date of delivery of the goods to the authorized service station if the warranty period has expired. If the failure cannot be repaired within 10 working days, the manufacturer or importer shall allocate another good with similar characteristics to the use of the consumer until the repair of the goods is completed. If the goods fail within the warranty period, the period spent in repair shall be added to the warranty period.

7) Failures resulting from the use of the goods contrary to the points stated in the instruction manual are not covered by the warranty.

8) The consumer may apply to the **Consumer Arbitration Committee or the Consumer Court** of his/her residence or at the jurisdiction of the place where the consumer transaction is performed in case of any disputes regarding the exercise of the rights arising from the warranty.



9) If this **Warranty Certificate** is not provided by the seller, the consumer may apply to the **General Directorate of Consumer Protection and Market Surveillance of the Ministry of Customs and Trade**.

The minimum service life specified by the Ministry of Customs and Trade for these devices is 10 years. During this period, the manufacturer and seller companies undertake to service the device and to provide spare parts.

**When the boilers are commissioned by the Authorized Service, you have to sign the form below and submit it to the service, and have the “Warranty Certificate” signed by the authorized service. It is highly recommended that you follow the operating instructions provided here to ensure trouble-free operation of the boiler over long periods of time.**



## 8.1. Rima Condensing Boiler Commissioning Form

 Rima Isı Sistemleri San. ve Tic. AŞ.	<b>CONDENSING BOILER COMMISSIONING FORM</b>		Authorized Service Information  Rev.:03/2019			
	Certificate No.:					
Customer's Name and Phone						
Customer's Address						
Project Name						
Commissioning Date						
Authorized Dealer						
Installer						
Production Year of the Boiler						
Boiler Models and Numbers						
Serial Numbers of the Boilers						
<b>INSPECTION OF INSTALLATION</b>			Yes	No	Prioritized Warranty Conditions	
<b>General Specifications of Installation</b>						
1	Fuel Type	Natural Gas <input type="checkbox"/>	Propane <input type="checkbox"/>	(Operates with Natural Gas		X
2	Height of the Building (Number of Floors, Height in Meters?)					
3	Boiler Room	Roof <input type="checkbox"/>	Floor	Basement <input type="checkbox"/>		
4	Fresh Air Intake	From the Room <input type="checkbox"/>	From the Exterior <input type="checkbox"/>			
5	Phase Protection	..... Ampere	Voltage Protection..... Amp-			
6	Is Grounding Available?	(Commissioning is not allowed if grounding is not available!)			Is Residual Current Available? .....	X
7	What is the gas inlet pressure?					X
8	Is a filter available on the gas side?					X
9	Is a gas leak detector available?					
<b>Boiler Specifications</b>						
1	Flue Kit Installation	Plastic <input type="checkbox"/>	Metal Sheet <input type="checkbox"/>	Inclination %..... Down <input type="checkbox"/>	Up <input type="checkbox"/>	
2	Is there a flue flap on the flue outlet of the boiler?					
3	Are the boiler connected to the cascade flue from the sides?					
4	Is there an External Air Sensor, .....	mm2 Wire	Is it installed to the correct place?			
5	KIs there a boiler relief valve	How many bars is the pressure? .....			(It shall not exceed 6 bars)	X
6	Brand and model information for circulation pump under the boiler					X
7	Is the boiler circulation pump on the inlet line, is its direction correct?					X
8	Is there a valve before or after the boiler circulation pump?					
9	Is there a filter under the boiler, is its cross section proper?					X
10	Is there a check valve under each boiler if it is a cascade system? (check valve shall not be used in single boiler systems)					X
<b>Specifications of Installation</b>						
1	Is the drainage line properly installed?					X
2	Is there a boiler, Capacity.....	Boiler pump model .....	(A valve shall be used before-after the pump)			
3	Is there a three-way valve, Type .....	Is it installed?				
4	Content of the installation water used	Mains water <input type="checkbox"/>	Well water <input type="checkbox"/>			X
5	Is a water softening device available in the system?	Yes <input type="checkbox"/>	No <input type="checkbox"/>			
6	Boiler water measurement values Ph.....	Hardness.....				X
7	Is automatic water filling available? (Automatic water filling shall not be available!)					
8	Is lime, sludge or iron observed in the water present in the boiler installation?					X
9	Capacity of the closed expansion tank.....	L				
10	Is the initial pressure setting of the expansion tank performed	What is the operating pressure?	Bar			
11	Is there a balance vessel, diameter?...					X
12	Is there an air separator / automatic purger / air cylinder, Where....	Diameter (Balance tank shall be on the primary side of the inlet)				X
13	Is there a sediment trap/filter, Where .....	Diameter .....	(It shall be on the return line, on the secondary side)			X
14	Is there a plate heat exchanger?	Brand .....				
15	Is there an expansion tank on both sides if a plate exchanger is available?					X
16	Heating Circuit	Radiator <input type="checkbox"/>	Floor Heating <input type="checkbox"/>	Boiler <input type="checkbox"/>	Pool <input type="checkbox"/>	A/C Plant <input type="checkbox"/>
<b>COMMISSIONING</b>						
1	UNIT HAS BEEN COMMISSIONED, OPERATING MANUAL AND WARRANTY CERTIFICATE ARE DELIVERED, OPERATION IS					
2	UNIT HAS NOT BEEN ACTIVATED DUE TO THE CONDITIONS SPECIFIED IN ARTICLES ...					
<b>IMPORTANT NOTES</b>						
1	KEEP YOUR UNIT IN OPERATING CONDITION TO PREVENT FREEZING IN WINTER					
2	WE RECOMMEND YOU TO HAVE THE PREVENTIVE MAINTENANCE OF YOUR UNIT PERFORMED BY THE AUTHORIZED SERVICE AT LEAST ONCE PER YEAR					
3	FAILURES THAT MAY RESULT FROM CONDITIONS SUCH AS UNINTENDED OPERATION, FAILURES IN THE ELECTRICAL INSTALLATION, VOLTAGE VALUE REACHING +- 10% OF 220V, VOLTAGE FLUCTUATION, IMPROPER GROUNDING					
4	AND INTERVENTION OF UNAUTHORIZED PERSONS, LACK OF MAINTENANCE IMPROPER OPERATION ARE OUT OF WARRANTY COVER.					
5	Was the customer/contractor informed about the issue?					
<b>Service Remark</b>						
Signature of Inspector			Customer Name-Signature			
I have checked the validity of the information provided above			I have read and confirm that the information is correct. I received my operating instructions and warranty documents			



## 8.2. Operating Instructions

Wall Type Condensing Boilers shall operated with natural gas only. Boilers are certified to meet the requirements of the EU Gas Equipment Directive, Boiler Efficiency Directive, EMC and Low Voltage Directive.

1. The instructions of the main authorized natural gas distribution directorates of each region shall be taken for the boilers. The installation shall be checked for natural gas leakage, and for any problems with electrical installation, alarm installation and natural gas installation by the times as specified by the main authorized directorates. The bottom and top ventilation requirements determined by the local gas office shall be followed. Ventilation vents shall not be closed.
2. Authorized boiler personnel should be provided with training on boiler operation by Rima authorized service during commissioning.
3. Water shall not be added when the boiler is hot. Boiler rooms where automatic conditioning is applied are out of warranty cover. It is important that the installation water is not replaced in any condition other than periodical maintenance, and formation of sludge and excessive contamination of the installation water.
4. Check the water level of the installation from the hydrometer before igniting the boiler. Adjust water pressure by adding water if it is not adequate. Water shall not be added when the boiler is hot. Boiler rooms where automatic conditioning is applied are out of warranty cover.
5. The pH value of the condensate shall be between 7 and 8.5, and the hardness value appropriate to the capacity shall be determined in accordance with the table given below.

Total capacity (kW)	Total hardness (French hardness - ° F)		
	Total volume of the system (less than 20 l/kW)	Total volume of the system (between 20-50 l/kW)	Total volume of the system (higher than 50 l/kW)
≤50	≤30	≤20	<0.2
>50≤200	≤20	≤15	<0.2
>200≤600	≤15	<0.2	<0.2
>600	<0.2	<0.2	<0.2

Water containing sediment or of unknown content such as well water and transport water shall not be used. Damage to the products as a result of the use of any chemicals added to clean the installation and to condition the water without the manufacturer's approval shall render the manufacturer's warranty void. We recommend the use of water treatment products with Sentinel X100 brand.

6. After the commissioning of the boilers, all installation water shall be drained (against freezing) if the boiler is not to be operated.
7. Before the commissioning and during the operation, the boilers shall be protected against external factors such as dust, soot, construction debris etc. The presence of blockages in the heating installation such as dirt, sediment, burrs, iron dust, lime, etc., adversely affect the operation of the boiler. This may cause inefficient operation, overheating, noisy operation, and damage to the heat exchanger of the boiler over time. It is the user's responsibility to ensure that the water to be circulated in the installation is clean. The product shall be out of warranty cover in case of problems caused by this condition.
8. Boilers and boiler automation panels (particularly the materials of the electronics) shall be protected against damp environments before the commissioning and during operation.
9. The flue gas and the condensate in the flue shall be fully sealed.

10. In order to active the frost protection function of the boiler at low temperatures properly, the power and gas connections shall be turned on and condensation drain shall not be clogged.

11. It is important to use a voltage regulator in areas where voltage fluctuations occur in order to prevent damage to the boiler and control panel. Refer to the operating manual for recommended voltage ratings.

12. Check that the gas detector is in operating condition.

13. There must be absolutely no flow cut-off valves in the connection of the expansion tank and relief valve of the boiler. The relief valve shall have two redundancies both on the boiler and elsewhere where the valve is not connected (such as the expansion tank connection etc.). It shall be checked by authorized service and authorized users whether it operates and opens at appropriate pressure values. Adjustable relief valves shall not be used.

14. The use of plate heat exchangers is especially recommended for transformations from liquid fuel boilers and coal boilers/room heaters to condensing boilers. Manufacturer is responsible for cleaning of the water in closed systems.

15. If the closed expansion tank pressure is inadequate, adjust it with a portable air compressor. If the pressure is too high, adjust it using the valve.

16. There is no internal flue flap inside the boilers. For cascade systems, we recommend using an external flap.

17. There shall be a sediment trap and a check valve present under each boiler.

**IMPORTANT:** For the long-lasting and efficient operation of your boilers, have them maintained by the authorized ..... service periodically at least once a year.

**IMPORTANT:** Contact Rima authorized service in case of a fault.

Central Contact: 0212 485 48 74

### 8.3 Operating Instructions

 Rima Isı Sistemleri San. ve Tic. AŞ.		<b>INSPECTION OF THE CONDENSING BOILER SYSTEM</b> Revision: 03/2019		Authorized Service Information		
Date						
Name of the Installation Location of the						
Address of the Installation Location of the						
Name of the Seller						
Name of the Installer						
Production Year of the Boiler						
Commissioning Date of the Boiler						
Boiler Models and Numbers						
Serial Numbers of the Boilers						
SYSTEM INSPECTION				Yes	No	Prioritized Warranty Conditions
Unit Installation Location:		Roof <input type="checkbox"/>	Floor <input type="checkbox"/>	Basement <input type="checkbox"/>		
Height of the Building (Number of Floors, Height in Meters?)						
Is the boiler installation a new installation or is it transformed from a different fuel (coal, fuel oil)						
System Pressure (How many Bars ?)						
Fuel Type		Natural Gas <input type="checkbox"/>	Propane <input type="checkbox"/>	(Operates with Natural Gas Only!)		X
Flue Kit Installation Plastic D Metal Sheet D Inclinatıon% .....		Down D Up D				X
Is there an external flap on the flue outlet of the boiler?						
<b>Are the boiler connected to the cascade flue from the sides?</b>						X
Is the cascade boiler flue inclined?						X
Does the cascade boiler flue have a drainage connection?						X
Is the power connection proper? (How many Amperes?)						X
Is grounding available, is there residual current? (Commissioning is not allowed if grounding is not available!)						X
Is a drainage line available?						
Are the condensate vessels connected to drainage line?						
Is it a cascade system, or is it designed as a single boiler?		Single <input type="checkbox"/>	Cascade <input type="checkbox"/>			
Are the control equipment installed?						
Is there a boiler, Capacity l						
Is there a three-way valve, Type .....		... Is it installed?				
Is there an External Air Sensor? .....		mm2 Wire	Is it installed?			
Is there a water leak in the installation?						X
Is there an automatic supply device?						
Is there a boiler relief valve? (How many bars?) It shall be ≤ 6 bar						X
Content of the installation water used:		Mains water <input type="checkbox"/>	Well water <input type="checkbox"/>			X
<b>Boiler water measurement values Ph</b>		Hardness .....				X
Is lime, sludge or iron observed in the water present in the boiler installation?						X
Is the installation water support on the inlet, or is it on the return? (Hose connection is not desired)						
Is there an expansion tank, Open l.....Closed <input type="checkbox"/>		Initial pressure..... bar .....	Valve Yes <input type="checkbox"/>	No <input type="checkbox"/>		X
Is the initial pressure setting of the expansion tank performed?						
Brand and model information for circulation pump under the boiler						X
Is the boiler circulation pump on the return line?						X
Is there a valve before or after the boiler circulation pump?						
System pump brand and model						
Is there a balance vessel, diameter?						
If a balance vessel is available, where is the location of the expansion tank, is it before the balance vessel?						X
Is there a plate heat exchanger?						
Is there an expansion tank on both sides if a plate exchanger is available?						X
Is there a filter on the inlet of each boiler in a cascade system, diameter (filter is not required in single boiler systems)						X
Is there an air separator / automatic purger / air cylinder? Where? .....		Diameter .....	(It shall be on the supply, on the primary side)			X
(It shall be on the return, on the secondary installation side before the balance vessel)						X
Diameter of the installation before the balance vessel						
Is there a heating Circuit..		Radiator <input type="checkbox"/>	Floor Heating <input type="checkbox"/>	A/C Plant <input type="checkbox"/>	Boiler <input type="checkbox"/>	Pool <input type="checkbox"/>
<b>Gas inlet pressure</b>						
Is a filter available on the gas side?						X
Is a gas leak detector available?						
Was the customer/contractor informed about the issue?						
Service Remark						
Signature of Inspector				Customer Name-Signature		



Manufacturer

Önmetal Döküm San. Tic.

Edirne Org. San. Böl. 4. Cad. No:3-5 Domurcalı/ Sülođlu/ EDİRNE

Tel: 0284 316 20 40

To get information on subjects related with sales:

Rima Isı Sis. San. A.Ş.

İkitelli OSB Mah. 25. Cad. No:10 Başakşehir/İSTANBUL

Tel: 0212 485 48 74

To get information on after-sales services:

Rima Isı Sis. San. A.Ş.

İkitelli OSB Mah. 25. Cad. No:10 Başakşehir/İSTANBUL

Tel: 0212 485 48 74



**Rima Isı Sistemleri San. A.Ş.**

İkitelli OSB Mah. 25.Cad. No:10 Başakşehir 34306 İstanbul

Tel:(0212) 48548 74 pbx

[www.rima.com.tr](http://www.rima.com.tr)

[www.onmetal.com.tr](http://www.onmetal.com.tr)



Rev 01/August 2019

All rights are reserved. Rima reserves the right to make changes on all their products without giving prior information.